



# Hardware Reference Guide

HP ProDesk 400 G3 MT Business PC

© Copyright 2015 HP Development Company, L.P.

Microsoft and Windows are either registered trademarks or trademarks of Microsoft Corporation in the United States and/or other countries.

The information contained herein is subject to change without notice. The only warranties for HP products and services are set forth in the express warranty statements accompanying such products and services. Nothing herein should be construed as constituting an additional warranty. HP shall not be liable for technical or editorial errors or omissions contained herein.

First Edition: July 2015

Document part number: 822842-001

### **Product notice**

This guide describes features that are common to most models. Some features may not be available on your computer.

Not all features are available in all editions of Windows 8. This computer may require upgraded and/or separately purchased hardware, drivers and/or software to take full advantage of Windows 8 functionality. See <http://www.microsoft.com> for details.

This computer may require upgraded and/or separately purchased hardware and/or a DVD drive to install the Windows 7 software and take full advantage of Windows 7 functionality. See <http://windows.microsoft.com/en-us/windows7/get-know-windows-7> for details.

### **Software terms**

By installing, copying, downloading, or otherwise using any software product preinstalled on this computer, you agree to be bound by the terms of the HP End User License Agreement (EULA). If you do not accept these license terms, your sole remedy is to return the entire unused product (hardware and software) within 14 days for a refund subject to the refund policy of your place of purchase.

For any further information or to request a full refund of the computer, please contact your local point of sale (the seller).

## About This Book

This guide provides basic information for upgrading the HP ProDesk Business PC.

---

 **WARNING!** Text set off in this manner indicates that failure to follow directions could result in bodily harm or loss of life.

 **CAUTION:** Text set off in this manner indicates that failure to follow directions could result in damage to equipment or loss of information.

 **NOTE:** Text set off in this manner provides important supplemental information.

---



---

# Table of contents

<b>1 Product features</b>	<b>1</b>
Standard configuration features	1
Front panel components	2
Rear panel components	3
Serial number location	4
<b>2 Hardware upgrades</b>	<b>5</b>
Serviceability features	5
Warnings and cautions	5
Removing the computer access panel	6
Replacing the computer access panel	7
Removing the front bezel	8
Removing an optical drive bezel blank	9
Replacing the front bezel	9
System board connections	10
Installing additional memory	11
DIMMs	11
DDR4-SDRAM DIMMs	11
Populating DIMM sockets	11
Installing DIMMs	12
Removing or installing an expansion card	14
Drive positions	18
Removing and Installing drives	19
Removing a 9.5mm slim optical drive	20
Installing a 9.5mm slim optical drive	21
Removing a 3.5-inch hard drive	23
Installing a 3.5-inch hard drive	24
Removing a 2.5-inch hard drive	25
Installing a 2.5-inch hard drive	26
Installing a security lock	28
Cable lock	28
Padlock	28
HP Business PC Security Lock V2	29
<b>Appendix A Battery replacement</b>	<b>34</b>

<b>Appendix B Electrostatic discharge .....</b>	<b>37</b>
Preventing electrostatic damage .....	37
Grounding methods .....	37
<b>Appendix C Computer operating guidelines, routine care and shipping preparation .....</b>	<b>38</b>
Computer operating guidelines and routine care .....	38
Optical drive precautions .....	39
Operation .....	39
Cleaning .....	39
Safety .....	39
Shipping preparation .....	39
<b>Appendix D Accessibility .....</b>	<b>40</b>
Supported assistive technologies .....	40
Contacting support .....	40
<b>Index .....</b>	<b>41</b>

---

# 1 Product features

## Standard configuration features

Features may vary depending on the model. For support assistance and to learn more about the hardware and software installed on your computer model, run the HP Support Assistant utility.



## Front panel components

Drive configuration may vary by model. Some models have a bezel blank covering the optical drive bay.

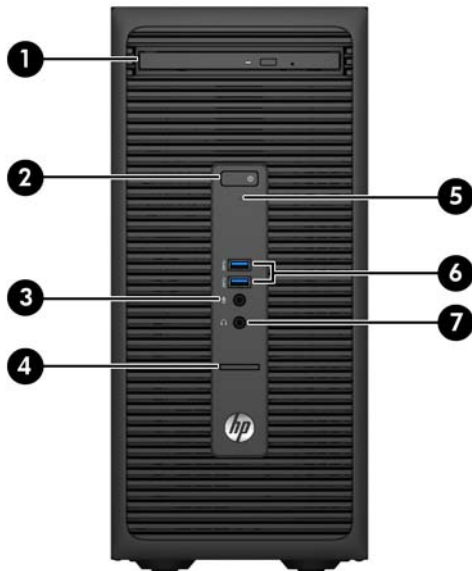









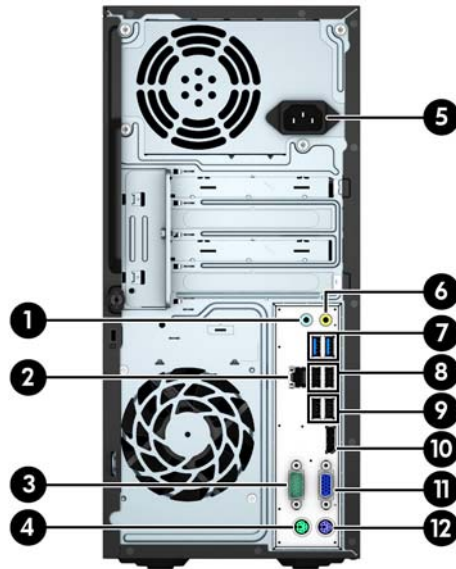



1	Slim Optical Drive (optional)	5	Hard Drive Activity Light
2	Dual-State Power Button	6	USB 3.0 Ports (blue)
3	Microphone Connector	7	Headphone Connector
4	SD Card Reader (optional)		

**NOTE:** The Power On Light is normally white when the power is on. If it is flashing red, there is a problem with the computer and it is displaying a diagnostic code. Refer to the *Maintenance and Service Guide* to interpret the code.



## Rear panel components



1		Line-In Audio Connector (blue)	7		USB 3.0 Ports (blue)
2		RJ-45 Network Connector	8		USB 2.0 Ports (black)
3		Serial Connector	9		USB 2.0 Ports with Wake from S4/S5 feature (black)
4		PS/2 Mouse Connector (green)	10		DisplayPort Monitor Connector
5		Power Cord Connector	11		VGA Monitor Connector
6		Line-Out Connector for powered audio devices (green)	12		PS/2 Keyboard Connector (purple)

**NOTE:** An optional second serial port and an optional parallel port are available from HP.

If using a USB keyboard, HP recommends connecting the keyboard to one of the USB 2.0 ports with the wake from S4/S5 feature. The wake from S4/S5 feature is also supported on the PS/2 connectors if enabled in BIOS F10 Setup.

When a graphics card is installed in one of the system board slots, the video connectors on the graphics card and the integrated graphics on the system board may be used at the same time. However, for such a configuration, only the display connected to the discrete graphics card will display POST messages.

The system board graphics can be disabled by changing settings in Computer Setup.

## Serial number location

Each computer has a unique serial number and a product ID number that are located on the exterior of the computer. Keep these numbers available for use when contacting customer service for assistance.



---

## 2 Hardware upgrades

### Serviceability features

The computer includes features that make it easy to upgrade and service. A Torx T15 or flathead screwdriver is needed for many of the installation procedures described in this chapter.

### Warnings and cautions

Before performing upgrades be sure to carefully read all of the applicable instructions, cautions, and warnings in this guide.

---

 **WARNING!** To reduce the risk of personal injury from electrical shock, hot surfaces, or fire:

Disconnect the power cord from the wall outlet and allow the internal system components to cool before touching.

Do not plug telecommunications or telephone connectors into the network interface controller (NIC) receptacles.

Do not disable the power cord grounding plug. The grounding plug is an important safety feature.

Plug the power cord in a grounded (earthed) outlet that is easily accessible at all times.

To reduce the risk of serious injury, read the *Safety & Comfort Guide*. It describes proper workstation, setup, posture, and health and work habits for computer users, and provides important electrical and mechanical safety information. This guide is located on the Web at <http://www.hp.com/ergo>.

 **WARNING!** Energized and moving parts inside.

Disconnect power to the equipment before removing the enclosure.

Replace and secure the enclosure before re-energizing the equipment.

 **CAUTION:** Static electricity can damage the electrical components of the computer or optional equipment. Before beginning these procedures, ensure that you are discharged of static electricity by briefly touching a grounded metal object. See [Electrostatic discharge on page 37](#) for more information.

When the computer is plugged into an AC power source, voltage is always applied to the system board. You must disconnect the power cord from the power source before opening the computer to prevent damage to internal components.

---

## Removing the computer access panel

To access internal components, you must remove the access panel:

1. Remove/disengage any security devices that prohibit opening the computer.
2. Remove all removable media, such as compact discs or USB flash drives, from the computer.
3. Turn off the computer properly through the operating system, then turn off any external devices.
4. Disconnect the power cord from the power outlet and disconnect any external devices.

---

**⚠ CAUTION:** Regardless of the power-on state, voltage is always present on the system board as long as the system is plugged into an active AC outlet. You must disconnect the power cord to avoid damage to the internal components of the computer.

---

5. Loosen the thumbscrew on the rear of the computer (1), and then slide the panel back (2) and lift it off the computer (3).

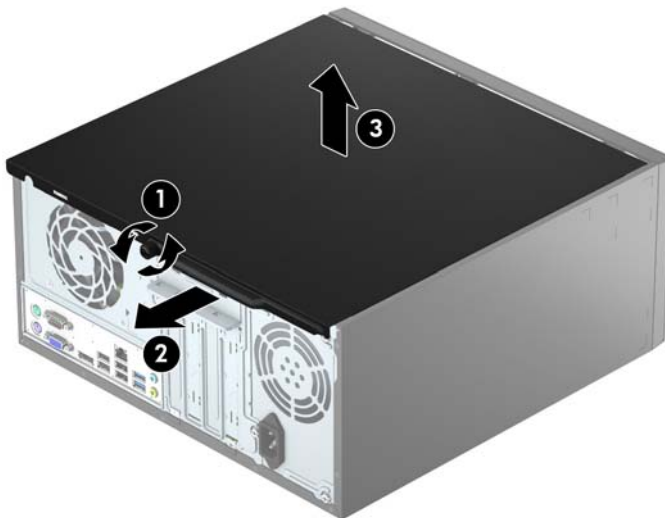

## Replacing the computer access panel

Place the panel on the computer (1), and then slide it forward (2) and tighten the thumbscrew (3) to secure the panel in place.

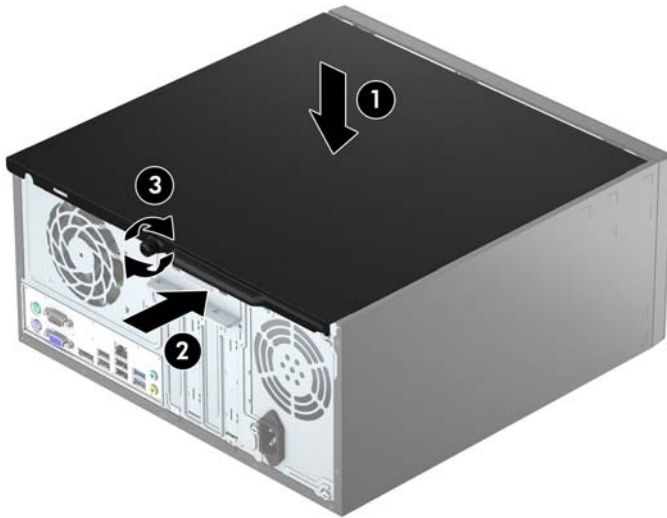

## Removing the front bezel

1. Remove/disengage any security devices that prohibit opening the computer.
2. Remove all removable media, such as compact discs or USB flash drives, from the computer.
3. Turn off the computer properly through the operating system, then turn off any external devices.
4. Disconnect the power cord from the power outlet and disconnect any external devices.

---

**⚠ CAUTION:** Regardless of the power-on state, voltage is always present on the system board as long as the system is plugged into an active AC outlet. You must disconnect the power cord to avoid damage to the internal components of the computer.

---

5. Remove the computer access panel.
6. Lift up the three tabs on the side of the bezel (1), and then rotate the bezel off the chassis (2).

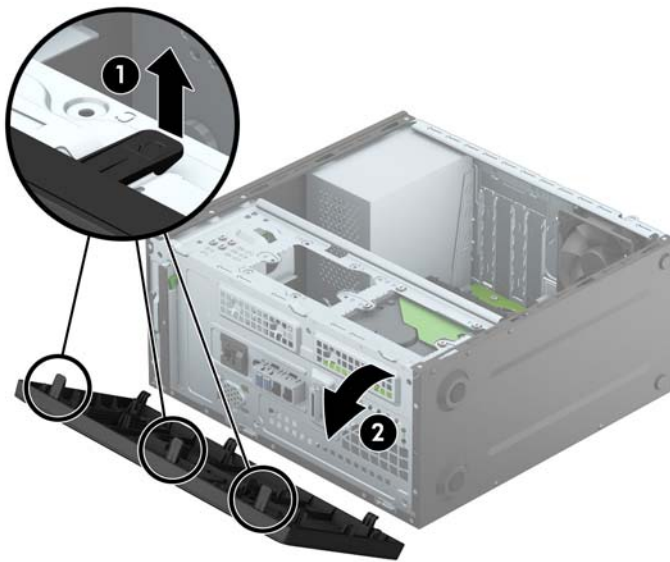

## Removing an optical drive bezel blank

On some models, there is a bezel blank covering the slim optical drive bay. Remove the bezel blank before installing an optical drive. To remove the bezel blank:

1. Remove the computer access panel and front bezel.
2. To remove the bezel blank, press upward on the bottom tab and press downward on the top tab on the side of the blank (1), and then rotate the blank off the front of the bezel (2).

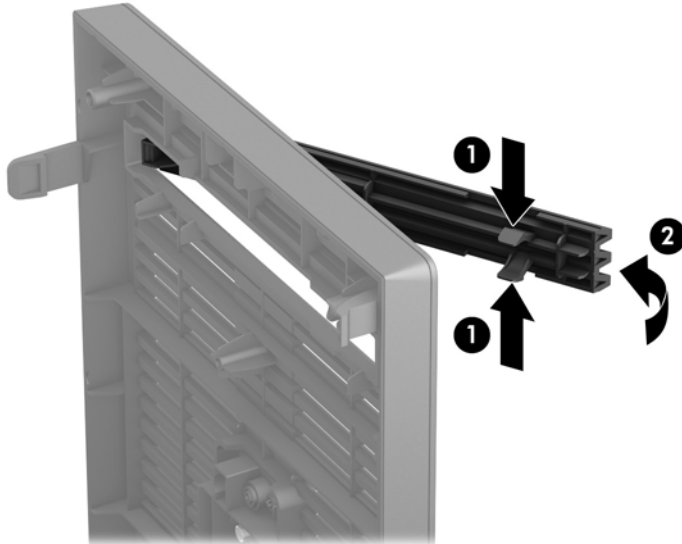

## Replacing the front bezel

Insert the three hooks on the bottom edge of the bezel into the rectangular holes on the chassis (1), and then rotate the top side of the bezel onto the chassis (2) and snap it into place.

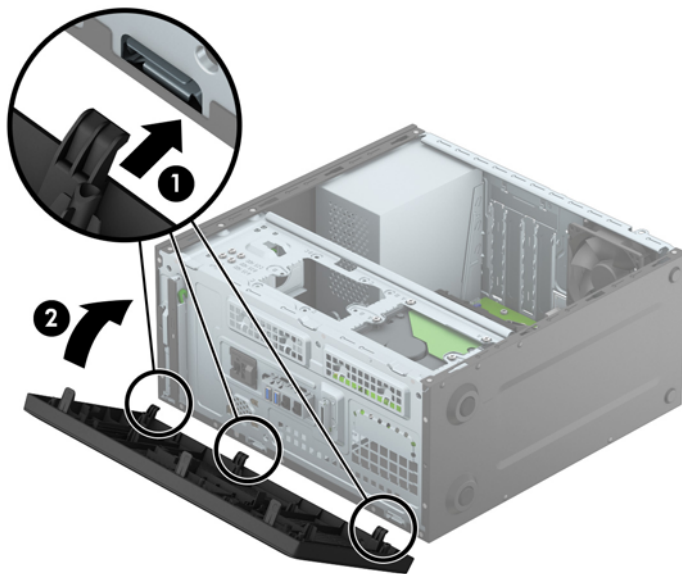

# System board connections

Refer to the following illustration and table to identify the system board connectors for your model.

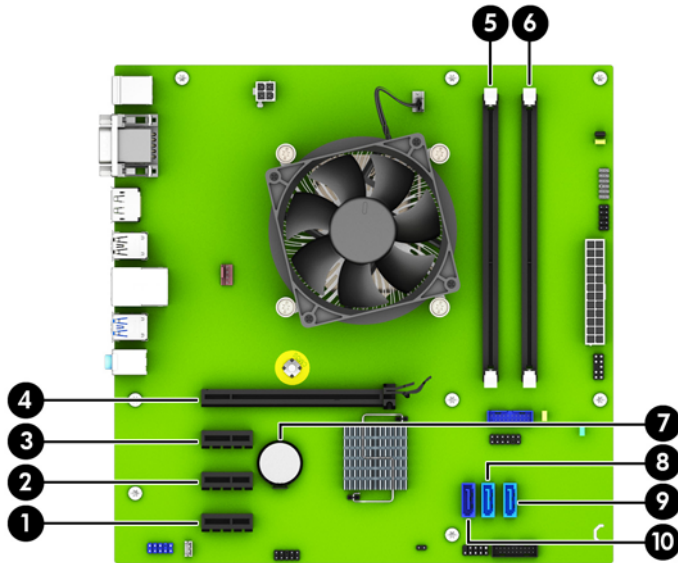

No.	System Board Connector	System Board Label	Color	Component
1	PCI Express x1	X1PCIEXP3	black	Expansion Card
2	PCI Express x1	X1PCIEXP2	black	Expansion Card
3	PCI Express x1	X1PCIEXP1	black	Expansion Card
4	PCI Express x16	X16PCIEXP	black	Expansion Card
5	DIMM3 (Channel A)	DIMM3	black	Memory Module
6	DIMM1 (Channel B)	DIMM1	black	Memory Module
7	Battery	BAT	black	Battery
8	SATA 3.0	SATA1	light blue	Any SATA Device other than the Primary Hard Drive
9	SATA 3.0	SATA2	light blue	Any SATA Device other than the Primary Hard Drive
10	SATA 3.0	SATA0	dark blue	Primary Hard Drive



# Installing additional memory

The computer comes with double data rate 4 synchronous dynamic random access memory (DDR4-SDRAM) dual inline memory modules (DIMMs).

## DIMMs

The memory sockets on the system board can be populated with up to two industry-standard DIMMs. These memory sockets are populated with at least one preinstalled DIMM. To achieve the maximum memory support, you can populate the system board with up to 32-GB of memory configured in a high-performing dual channel mode.

## DDR4-SDRAM DIMMs

For proper system operation, the DIMMs must be:

- industry-standard 288-pin
- unbuffered non-ECC PC4-17000 DDR4-2133 MHz-compliant
- 1.2 volt DDR4-SDRAM DIMMs

The DIMMs must also:

- support CAS latency 15 DDR4 2133 MHz (15-15-15 timing)
- contain the mandatory JEDEC SPD information

In addition, the computer supports:

- 512-Mbit, 1-Gbit, and 2-Gbit non-ECC memory technologies
- single-sided and double-sided DIMMs
- DIMMs constructed with x8 and x16 DDR devices; DIMMs constructed with x4 SDRAM are not supported



---

**NOTE:** The system will not operate properly if you install unsupported DIMMs.

---

## Populating DIMM sockets

There are two DIMM sockets on the system board, with one socket per channel. The sockets are labeled DIMM1 and DIMM3. Socket DIMM1 operates in memory channel B. Socket DIMM3 operates in memory channel A.

The system will automatically operate in single channel mode, dual channel mode, or flex mode, depending on how the DIMMs are installed.



---

**NOTE:** Single channel and unbalanced dual channel memory configurations will result in inferior graphics performance.

---

- The system will operate in single channel mode if the DIMM sockets are populated in one channel only.
- The system will operate in a higher-performing dual channel mode if the memory capacity of the DIMM in Channel A is equal to the memory capacity of the DIMM in Channel B.
- The system will operate in flex mode if the memory capacity of the DIMM in Channel A is not equal to the memory capacity of the DIMM in Channel B. In flex mode, the channel populated with the least amount of memory describes the total amount of memory assigned to dual channel and the remainder is

assigned to single channel. If one channel will have more memory than the other, the larger amount should be assigned to Channel A.

- In any mode, the maximum operational speed is determined by the slowest DIMM in the system.

## Installing DIMMs

---

**⚠ CAUTION:** You must disconnect the power cord and wait approximately 30 seconds for the power to drain before adding or removing memory modules. Regardless of the power-on state, voltage is always supplied to the memory modules as long as the computer is plugged into an active AC outlet. Adding or removing memory modules while voltage is present may cause irreparable damage to the memory modules or system board.

The memory module sockets have gold-plated metal contacts. When upgrading the memory, it is important to use memory modules with gold-plated metal contacts to prevent corrosion and/or oxidation resulting from having incompatible metals in contact with each other.

Static electricity can damage the electronic components of the computer or optional cards. Before beginning these procedures, ensure that you are discharged of static electricity by briefly touching a grounded metal object. For more information, refer to [Electrostatic discharge on page 37](#).

When handling a memory module, be careful not to touch any of the contacts. Doing so may damage the module.

- 
1. Remove/disengage any security devices that prohibit opening the computer.
  2. Remove all removable media, such as compact discs or USB flash drives, from the computer.
  3. Turn off the computer properly through the operating system, then turn off any external devices.
  4. Disconnect the power cord from the power outlet and disconnect any external devices.

---

**⚠ CAUTION:** You must disconnect the power cord and wait approximately 30 seconds for the power to drain before adding or removing memory modules. Regardless of the power-on state, voltage is always supplied to the memory modules as long as the computer is plugged into an active AC outlet. Adding or removing memory modules while voltage is present may cause irreparable damage to the memory modules or system board.

- 
5. Remove the computer access panel.

---

**⚠ WARNING!** To reduce risk of personal injury from hot surfaces, allow the internal system components to cool before touching.

---

6. Open both latches of the memory module socket (1), and insert the memory module into the socket (2).

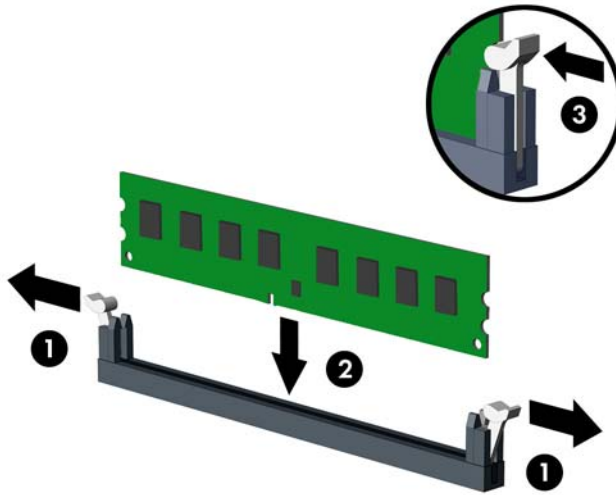

---

 **NOTE:** A memory module can be installed in only one way. Match the notch on the module with the tab on the memory socket.

For maximum performance, populate the sockets so that the memory capacity is spread as equally as possible between Channel A and Channel B. Refer to [Populating DIMM sockets on page 11](#) for more information.

---

7. Push the module down into the socket, ensuring that the module is fully inserted and properly seated. Make sure the latches are in the closed position (3).
8. Repeat steps 6 and 7 to install an additional module.
9. Replace the computer access panel.
10. Reconnect the power cord and any external devices, and then turn on the computer.
11. Lock any security devices that were disengaged when the access panel was removed.

The computer should automatically recognize the additional memory the next time you turn on the computer.

## Removing or installing an expansion card

The computer has three PCI Express x1 expansion sockets and one PCI Express x16 expansion socket.

 **NOTE:** You can install a PCI Express x1, x8, or x16 expansion card in the PCI Express x16 socket.

For dual graphics card configurations, the first (primary) card must be installed in the PCI Express x16 socket.

To remove, replace, or add an expansion card:

1. Remove/disengage any security devices that prohibit opening the computer.
2. Remove all removable media, such as compact discs or USB flash drives, from the computer.
3. Turn off the computer properly through the operating system, then turn off any external devices.
4. Disconnect the power cord from the power outlet and disconnect any external devices.

 **CAUTION:** Regardless of the power-on state, voltage is always present on the system board as long as the system is plugged into an active AC outlet. You must disconnect the power cord to avoid damage to the internal components of the computer.

5. Remove the computer access panel.
6. Remove the screw that holds down the expansion card retention latch (1), and then slide the latch up (2) and pull it off the rear of the chassis (3).

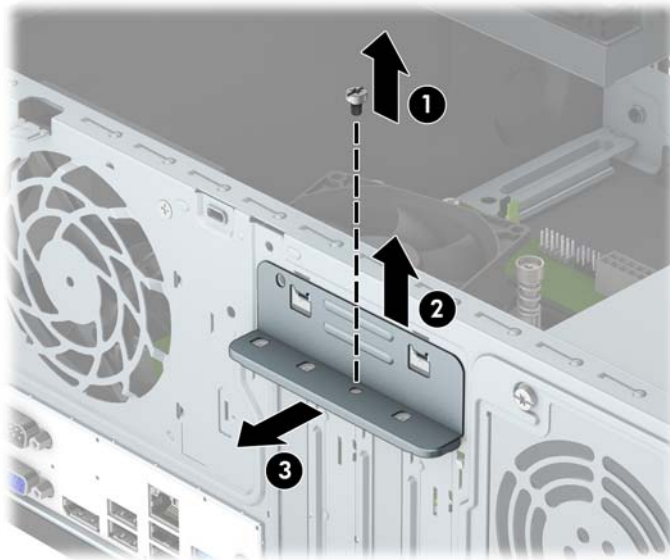

7. Locate the correct vacant expansion socket on the system board and the corresponding expansion slot on the back of the computer chassis.
8. Before installing an expansion card, remove the expansion slot cover or the existing expansion card.

 **NOTE:** Before removing an installed expansion card, disconnect any cables that may be attached to the expansion card.

- a. If you are installing an expansion card in a vacant socket, you must slide one of the expansion slot covers up and out of the chassis or use a flatblade screwdriver to pry out one of the metal shields on the rear panel that covers the expansion slot. Be sure to remove the appropriate shield for the expansion card you are installing.

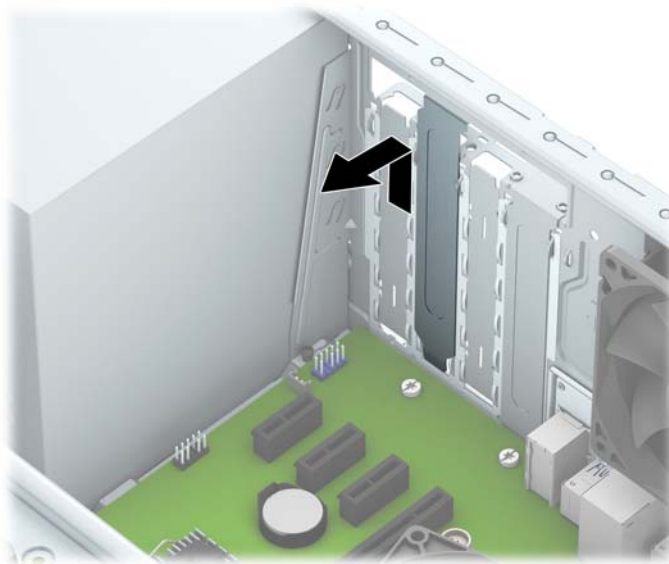

- b.** If you are removing a PCI Express x1 card, hold the card at each end and carefully rock it back and forth until the connectors pull free from the socket. Lift the card straight up (1) then away from the inside of the chassis (2) to remove it. Be sure not to scrape the card against other components.

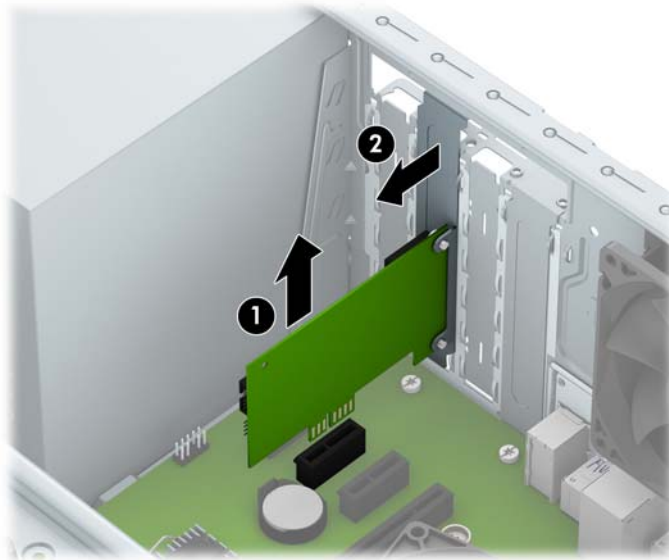

- c. If you are removing a PCI Express x16 card, pull the retention arm on the back of the expansion socket away from the card and carefully rock the card back and forth until the connectors pull free from the socket. Lift the card straight up then away from the inside of the chassis to remove it. Be sure not to scrape the card against other components.

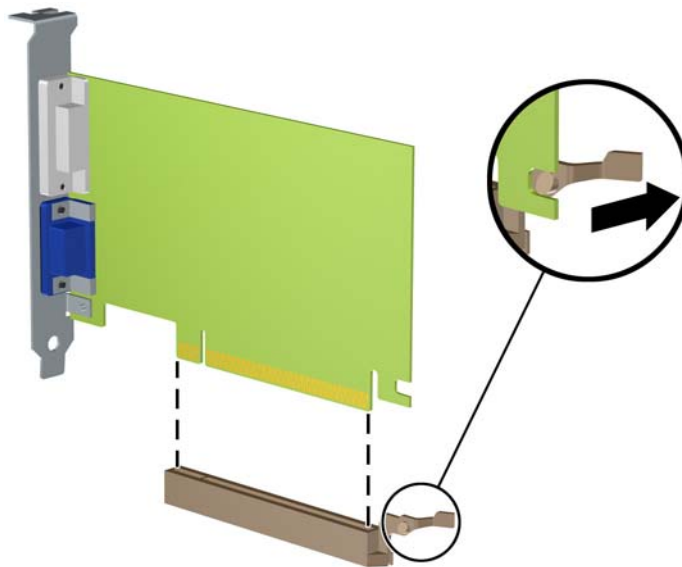

9. Store the removed card in anti-static packaging.
10. If you are not installing a new expansion card, install an expansion slot cover to close the open slot.

---

**CAUTION:** After removing an expansion card, you must replace it with a new card or expansion slot cover for proper cooling of internal components during operation.

---

11. To install a new expansion card, hold the card just above the expansion socket on the system board then move the card toward the rear of the chassis (1) so that the bottom of the bracket on the card slides into the small slot on the chassis. Press the card straight down into the expansion socket on the system board (2).

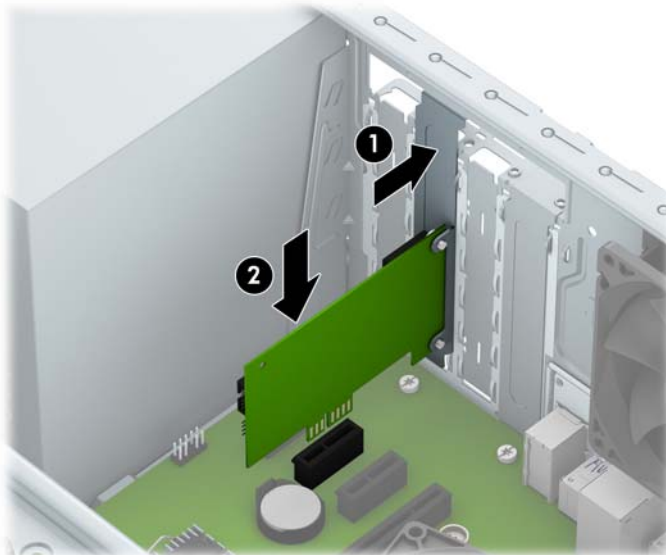

---

**NOTE:** When installing an expansion card, press firmly on the card so that the whole connector seats properly in the expansion card socket.

---

12. Press the expansion card retention latch against the back of the chassis (1) and slide it down (2) so that the tabs on the back of the latch slide into the notches on the chassis and then replace the screw that secures the latch (3).

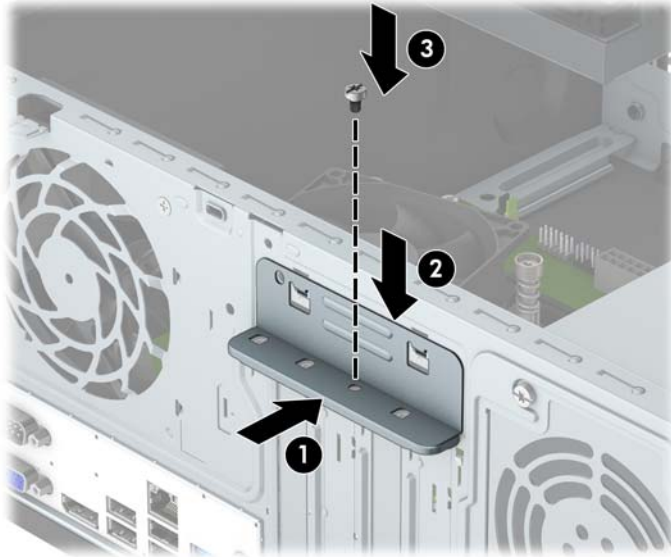

13. Connect external cables to the installed card, if needed. Connect internal cables to the system board, if needed.
14. Replace the computer access panel.
15. Reconnect the power cord and any external devices, and then turn on the computer.
16. Lock any security devices that were disengaged when the computer access panel was removed.
17. Reconfigure the computer, if necessary.

## Drive positions

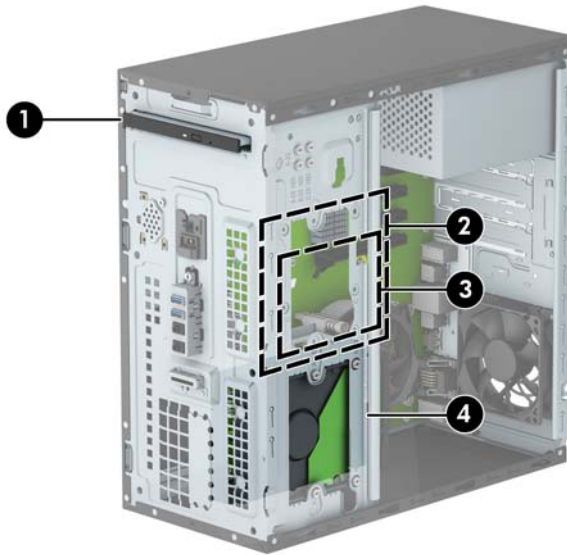

- 
- |   |                                  |
|---|----------------------------------|
| 1 | 9.5mm slim optical drive bay     |
| 2 | 3.5-inch internal hard drive bay |
| 3 | 2.5-inch internal hard drive bay |
| 4 | 3.5-inch internal hard drive bay |
- 

**NOTE:** The drive configuration on your computer may be different than the drive configuration shown above.

**NOTE:** The upper hard drive bay can contain either a 3.5-inch hard drive or a 2.5-inch hard drive, but not both.

---

To verify the type and size of the storage devices installed in the computer, run Computer Setup.



# Removing and Installing drives

When installing drives, follow these guidelines:

- The primary Serial ATA (SATA) hard drive must be connected to the dark blue primary SATA connector on the system board labeled SATA0.
- Connect secondary hard drives and optical drives to one of the light blue SATA connectors on the system board (labeled SATA1 and SATA2).
- HP has provided four extra 6-32 hard drive mounting screws installed on the front of the chassis behind the bezel (1). The mounting screws are required for 3.5-inch and 2.5-inch hard drives installed in the hard drive bays. If you are replacing a drive, remove the mounting screws from the old drive and install them in the new drive.

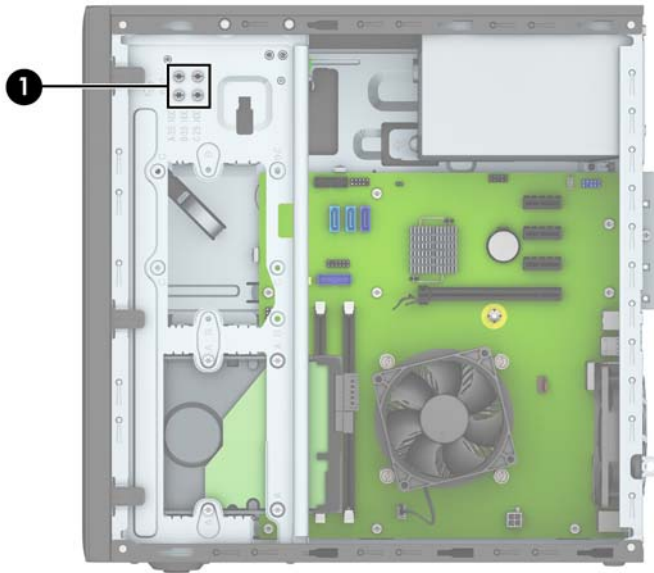

---

**CAUTION:** To prevent loss of work and damage to the computer or drive:

If you are inserting or removing a drive, shut down the operating system properly, turn off the computer, and unplug the power cord. Do not remove a drive while the computer is on or in standby mode.

Before handling a drive, ensure that you are discharged of static electricity. While handling a drive, avoid touching the connector. For more information about preventing electrostatic damage, refer to [Electrostatic discharge on page 37](#).

Handle a drive carefully; do not drop it.

Do not use excessive force when inserting a drive.

Avoid exposing a hard drive to liquids, temperature extremes, or products that have magnetic fields such as monitors or speakers.

If a drive must be mailed, place the drive in a bubble-pack mailer or other protective packaging and label the package "Fragile: Handle With Care."

---

## Removing a 9.5mm slim optical drive

1. Remove/disengage any security devices that prohibit opening the computer.
2. Remove all removable media, such as compact discs or USB flash drives, from the computer.
3. Turn off the computer properly through the operating system, then turn off any external devices.
4. Disconnect the power cord from the power outlet and disconnect any external devices.

---

**⚠ CAUTION:** Regardless of the power-on state, voltage is always present on the system board as long as the system is plugged into an active AC outlet. You must disconnect the power cord to avoid damage to the internal components of the computer.

---

5. Remove the computer access panel.
6. Disconnect the power cable (1) and data cable (2) from the rear of the optical drive.



---

**⚠ CAUTION:** When removing the cables, pull the tab or connector instead of the cable itself to avoid damaging the cable.

---

7. Push the green release latch on the right rear side of the drive inward (1) and slide the drive out of the drive bay (2).

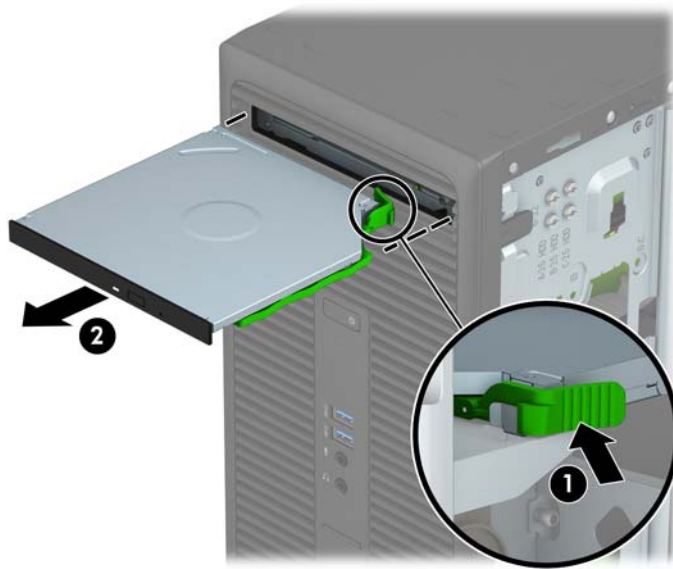

## Installing a 9.5mm slim optical drive

1. Remove/disengage any security devices that prohibit opening the computer.
2. Remove all removable media, such as compact discs or USB flash drives, from the computer.
3. Turn off the computer properly through the operating system, then turn off any external devices.
4. Disconnect the power cord from the power outlet and disconnect any external devices.

**⚠ CAUTION:** Regardless of the power-on state, voltage is always present on the system board as long as the system is plugged into an active AC outlet. You must disconnect the power cord to avoid damage to the internal components of the computer.

5. Remove the computer access panel.
6. If you are installing a slim optical drive in a bay covered by a bezel blank, remove the front bezel and then remove the bezel blank. See [Removing an optical drive bezel blank on page 9](#) for more information.
7. Follow the instructions for removing the optical drive if one was installed. Refer to [Removing a 9.5mm slim optical drive on page 20](#).

8. Align the small pin on the release latch with the small hole on the side of the drive and press the latch firmly onto the drive.



9. Slide the optical drive through the front bezel (1) all the way into the bay so that the green latch locks onto the chassis frame (2).

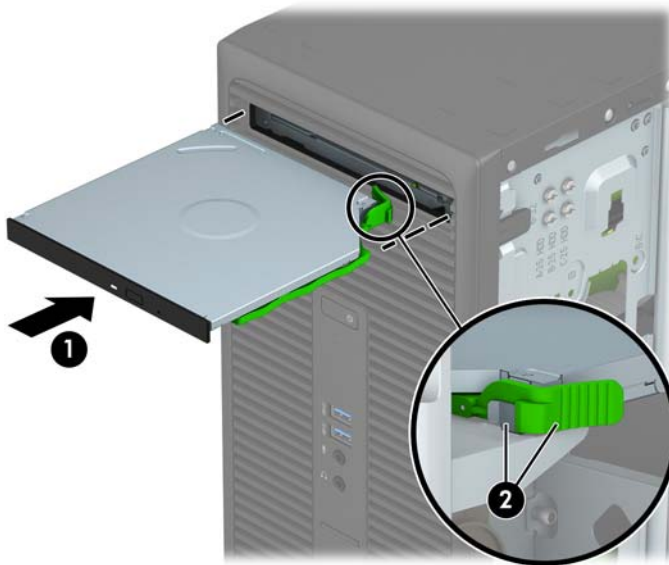

10. Connect the power cable (1) and data cable (2) to the rear of the optical drive.



11. If installing a new drive, connect the opposite end of the data cable to one of the light blue SATA connectors (labeled SATA1 and SATA2) on the system board.
12. Replace the front bezel if it was removed.
13. Replace the computer access panel.
14. Reconnect the power cord and any external devices, and then turn on the computer.
15. Lock any security devices that were disengaged when the access panel was removed.

## Removing a 3.5-inch hard drive

 **NOTE:** Before you remove the old hard drive, be sure to back up the data from the old hard drive so that you can transfer the data to the new hard drive.

1. Remove/disengage any security devices that prohibit opening the computer.
2. Remove all removable media, such as compact discs or USB flash drives, from the computer.
3. Turn off the computer properly through the operating system, then turn off any external devices.
4. Disconnect the power cord from the power outlet and disconnect any external devices.

 **CAUTION:** Regardless of the power-on state, voltage is always present on the system board as long as the system is plugged into an active AC outlet. You must disconnect the power cord to avoid damage to the internal components of the computer.

5. Remove the computer access panel.

6. Disconnect the data cable (1) and power cable (2) from the rear of the hard drive, and then remove the four 6-32 mounting screws (3) and slide the drive out of the bay (4).

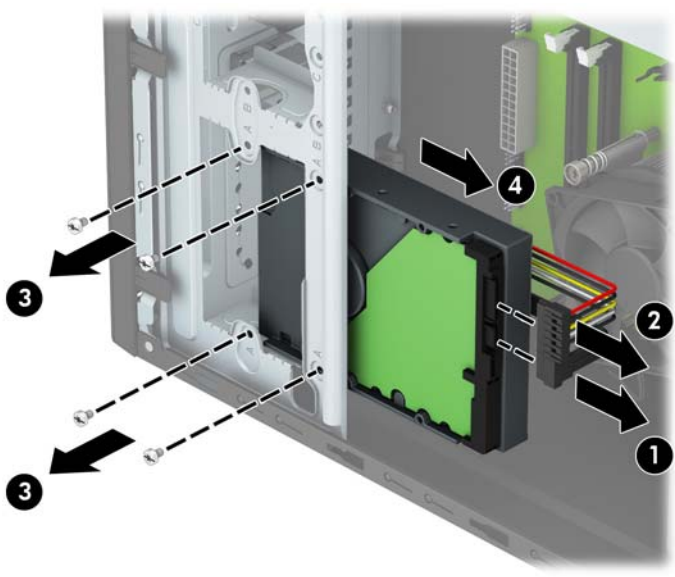

## Installing a 3.5-inch hard drive

1. Remove/disengage any security devices that prohibit opening the computer.
2. Remove all removable media, such as compact discs or USB flash drives, from the computer.
3. Turn off the computer properly through the operating system, then turn off any external devices.
4. Disconnect the power cord from the power outlet and disconnect any external devices.

**CAUTION:** Regardless of the power-on state, voltage is always present on the system board as long as the system is plugged into an active AC outlet. You must disconnect the power cord to avoid damage to the internal components of the computer.

5. Remove the computer access panel.

- Slide the drive into the drive bay (1) and install the four 6-32 mounting screws (2) to secure the drive in place. Connect the data cable (3) and power cable (4) to the rear of the hard drive.

 **NOTE:** HP has supplied four extra 6-32 mounting screws on the front of the chassis behind the bezel. Refer to [Removing and Installing drives on page 19](#) for an illustration of the location of the extra mounting screws. When replacing a hard drive, use the four 6-32 mounting screws that were removed from the old drive to install the new one.

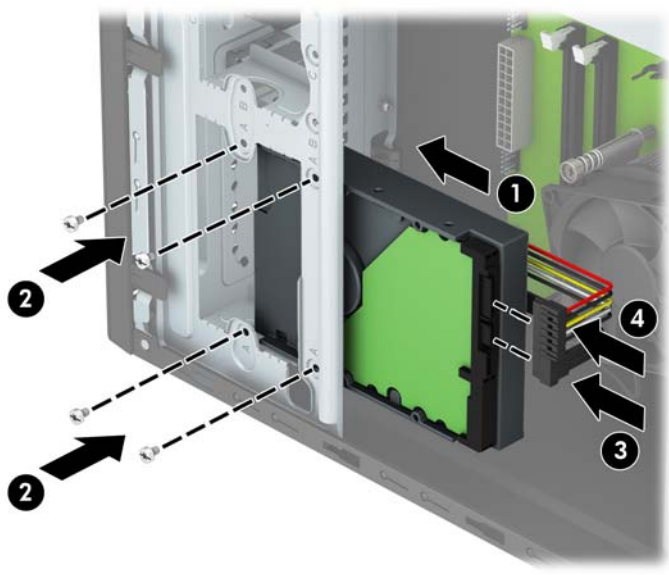

- If installing a new drive, connect the opposite end of the data cable to the appropriate system board connector.

 **NOTE:** You must connect the primary hard drive data cable to the dark blue connector labeled SATA0 to avoid any hard drive performance problems. If you are adding a second hard drive, connect the data cable to one of the light blue SATA connectors.

- Replace the computer access panel.
- Reconnect the power cord and any external devices, and then turn on the computer.
- Lock any security devices that were disengaged when the access panel was removed.

## Removing a 2.5-inch hard drive

 **NOTE:** Before you remove the old hard drive, be sure to back up the data from the old hard drive so that you can transfer the data to the new hard drive.

- Remove/disengage any security devices that prohibit opening the computer.
- Remove all removable media, such as compact discs or USB flash drives, from the computer.
- Turn off the computer properly through the operating system, then turn off any external devices.
- Disconnect the power cord from the power outlet and disconnect any external devices.

 **CAUTION:** Regardless of the power-on state, voltage is always present on the system board as long as the system is plugged into an active AC outlet. You must disconnect the power cord to avoid damage to the internal components of the computer.

- Remove the computer access panel.

6. Disconnect the data cable (1) and power cable (2) from the rear of the hard drive, and then remove the four 6-32 mounting screws (3) and slide the drive out of the bay (4).

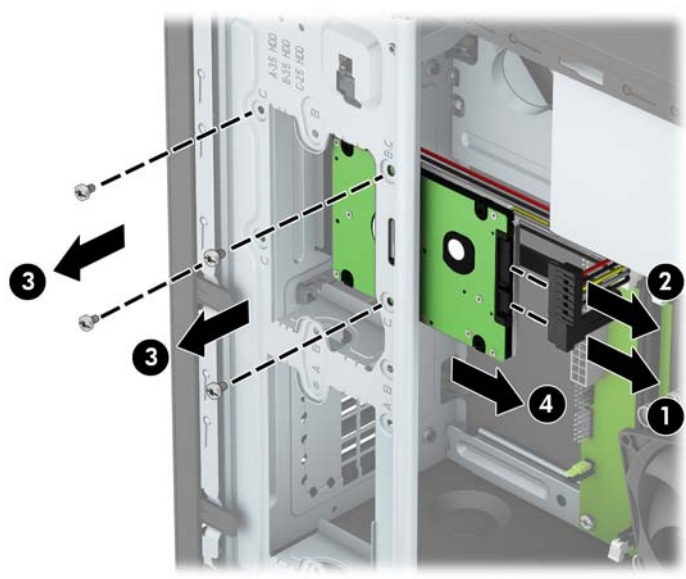

## Installing a 2.5-inch hard drive

1. Remove/disengage any security devices that prohibit opening the computer.
2. Remove all removable media, such as compact discs or USB flash drives, from the computer.
3. Turn off the computer properly through the operating system, then turn off any external devices.
4. Disconnect the power cord from the power outlet and disconnect any external devices.

**CAUTION:** Regardless of the power-on state, voltage is always present on the system board as long as the system is plugged into an active AC outlet. You must disconnect the power cord to avoid damage to the internal components of the computer.

5. Remove the computer access panel.



- Slide the drive into the drive bay (1) and install the four 6-32 mounting screws (2) to secure the drive in place. Connect the data cable (3) and power cable (4) to the rear of the hard drive.

 **NOTE:** HP has supplied four extra 6-32 mounting screws on the front of the chassis behind the bezel. Refer to [Removing and Installing drives on page 19](#) for an illustration of the location of the extra mounting screws. When replacing a hard drive, use the four 6-32 mounting screws that were removed from the old drive to install the new one.

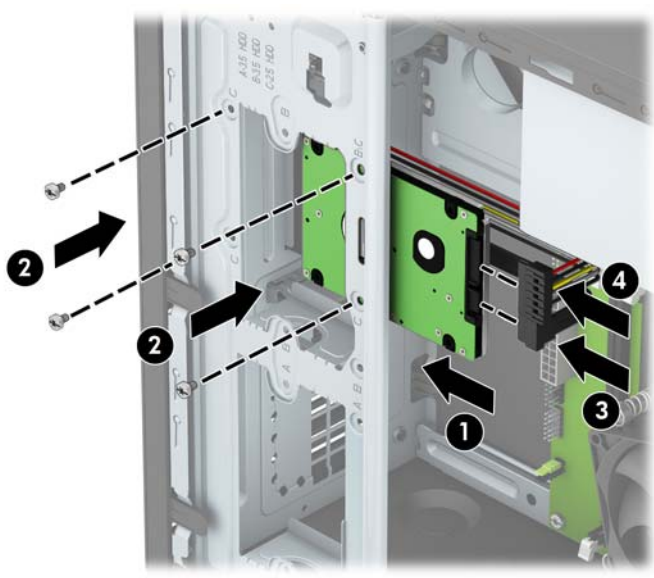

- If installing a new drive, connect the opposite end of the data cable to the appropriate system board connector.

 **NOTE:** You must connect the primary hard drive data cable to the dark blue connector labeled SATA0 to avoid any hard drive performance problems. If you are adding a second hard drive, connect the data cable to one of the light blue SATA connectors.

- Replace the computer access panel.
- Reconnect the power cord and any external devices, and then turn on the computer.
- Lock any security devices that were disengaged when the access panel was removed.

## Installing a security lock

The security locks displayed below and on the following page can be used to secure the computer.

### Cable lock



### Padlock

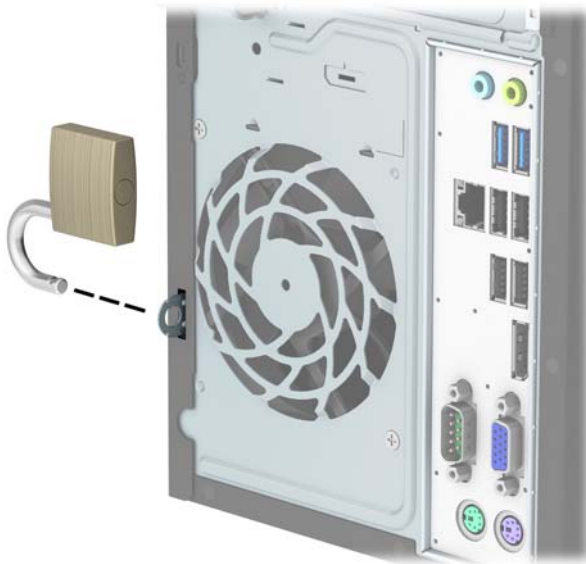

## HP Business PC Security Lock V2

1. Attach the security cable fastener to a desktop using the appropriate screws for your environment (screws not provided) (1), and then snap the cover onto the base of the cable fastener (2).

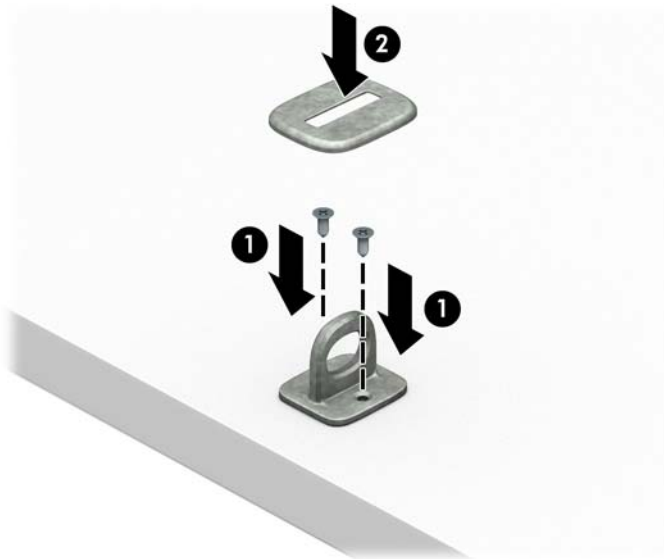

2. Loop the security cable around a stationary object.



3. Slide the security cable through the security cable fastener.

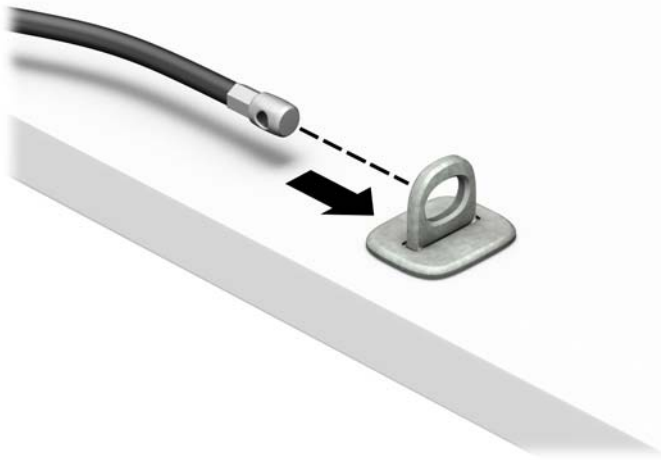

4. Pull the two scissor hands of the monitor lock apart and insert the lock into the security slot on the rear of the monitor (1), close the scissor hands together to secure the lock in place (2), and then slide the cable guide through the center of the monitor lock (3).

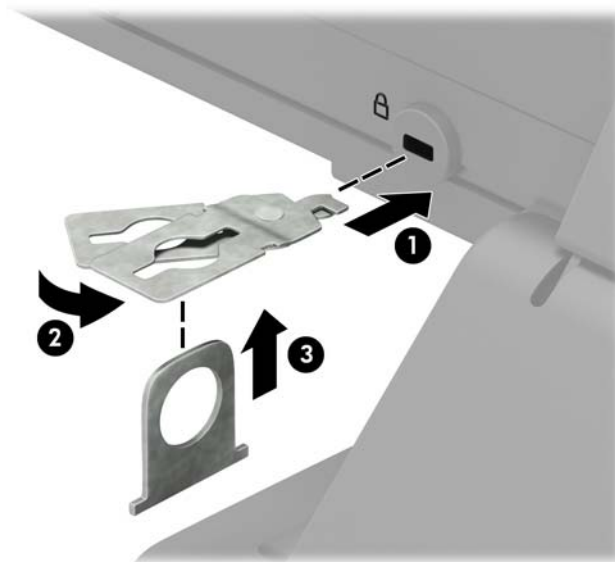

5. Slide the security cable through the security guide installed on the monitor.

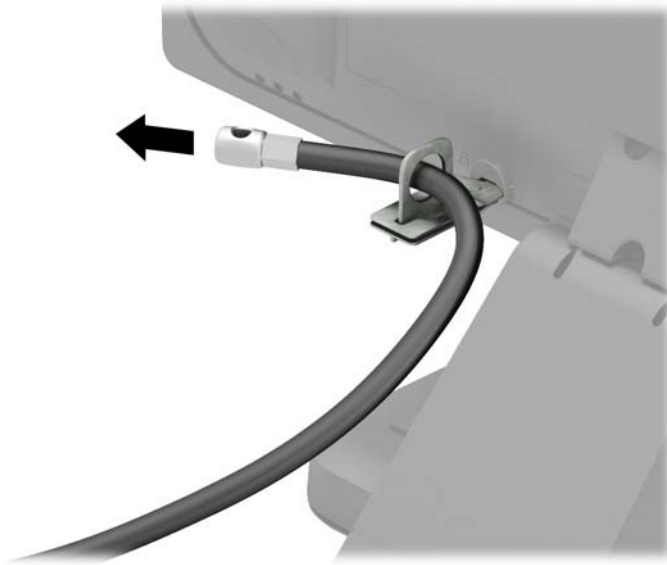

6. Attach the accessory cable fastener to a desktop using the appropriate screw for your environment (screw not provided) (1), and then place the accessory cables into the base of the fastener (2)

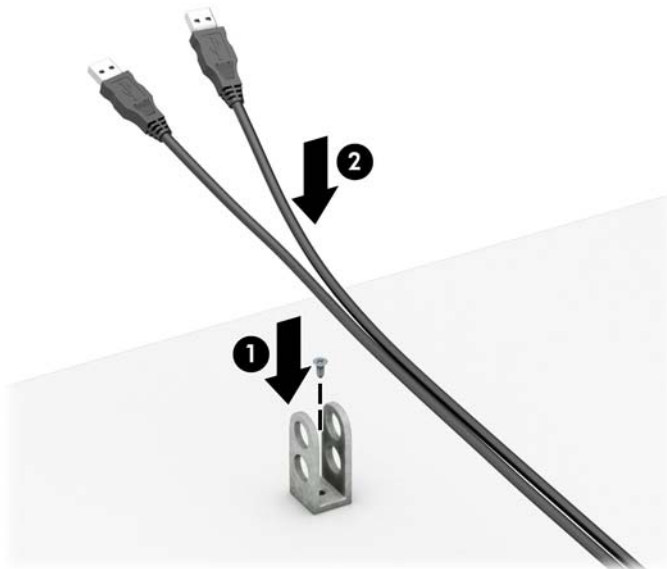

7. Slide the security cable through the holes in the accessory cable fastener.

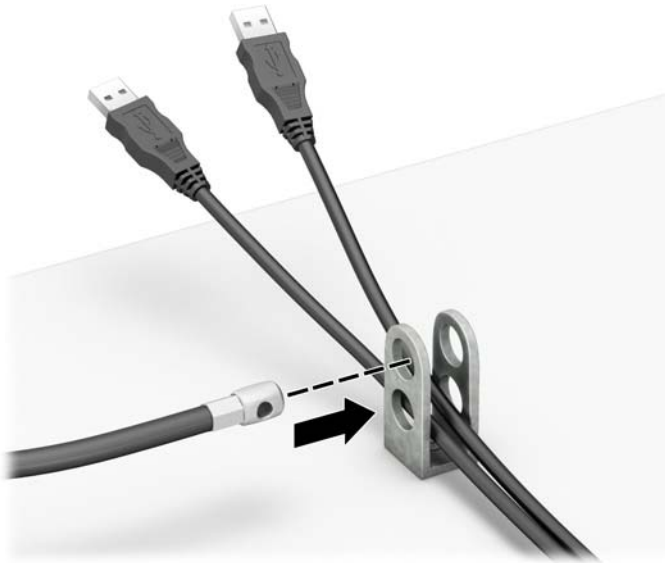

8. Remove the thumbscrew from the rear of the chassis and screw the lock to the chassis in the thumbscrew hole using the screw provided (1). Insert the plug end of the security cable into the lock (2) and push the button in (3) to engage the lock. Use the key provided to disengage the lock.

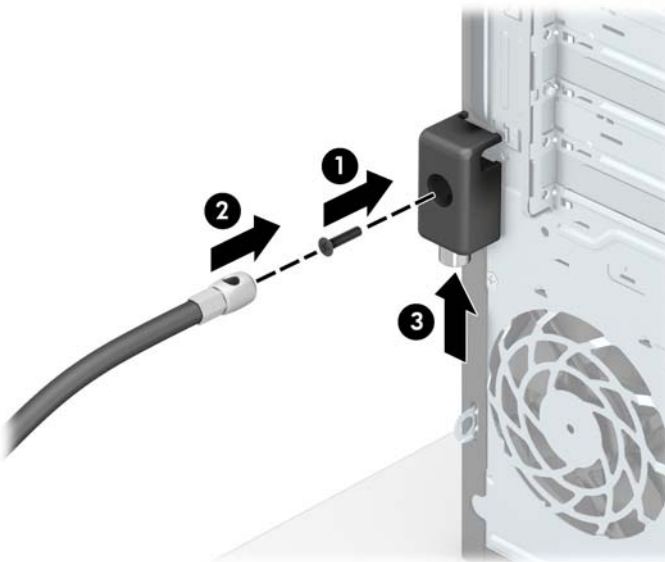

9. When you have completed all steps, all of the devices at your workstation will be secured.

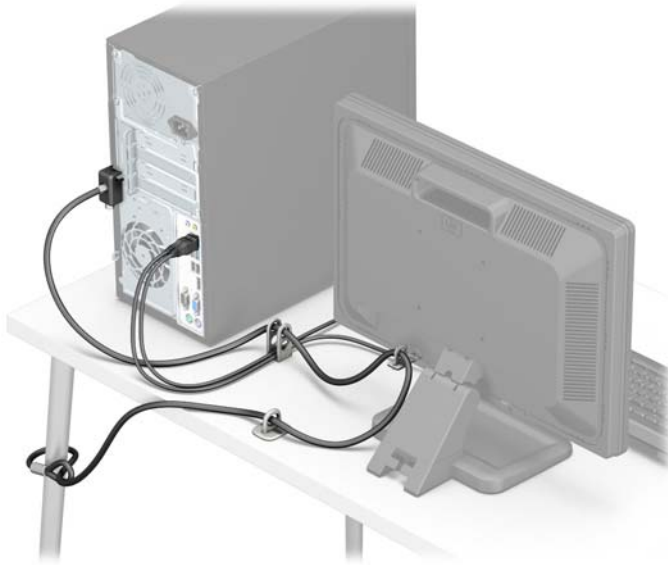

---

# A Battery replacement

The battery installed on the computer provides power to the real-time clock. When replacing the battery, use a battery equivalent to the battery originally installed on the computer. The computer has a 3-volt lithium coin cell battery installed.

---

 **WARNING!** The computer contains an internal lithium manganese dioxide battery. There is a risk of fire and burns if the battery is not handled properly. To reduce the risk of personal injury:

Do not attempt to recharge the battery.

Do not expose to temperatures higher than 60°C (140°F).

Do not disassemble, crush, puncture, short external contacts, or dispose of in fire or water.

Replace the battery only with the HP spare designated for this product.

 **CAUTION:** Before replacing the battery, it is important to back up the computer CMOS settings. When the battery is removed or replaced, the CMOS settings will be cleared.

Static electricity can damage the electronic components of the computer or optional equipment. Before beginning these procedures, ensure that you are discharged of static electricity by briefly touching a grounded metal object.

 **NOTE:** The lifetime of the lithium battery can be extended by plugging the computer into a live AC wall socket. The lithium battery is only used when the computer is NOT connected to AC power.

HP encourages customers to recycle used electronic hardware, HP original print cartridges, and rechargeable batteries. For more information about recycling programs, go to <http://www.hp.com/recycle>.

1. Remove/disengage any security devices that prohibit opening the computer.
2. Remove all removable media, such as compact discs or USB flash drives, from the computer.
3. Turn off the computer properly through the operating system, then turn off any external devices.
4. Disconnect the power cord from the power outlet and disconnect any external devices.

---

 **CAUTION:** Regardless of the power-on state, voltage is always present on the system board as long as the system is plugged into an active AC outlet. You must disconnect the power cord to avoid damage to the internal components of the computer.

5. Remove the computer access panel.
6. Locate the battery and battery holder on the system board.

---

 **NOTE:** On some computer models, it may be necessary to remove an internal component to gain access to the battery.

7. Depending on the type of battery holder on the system board, complete the following instructions to replace the battery.

## Type 1

- a. Lift the battery out of its holder.



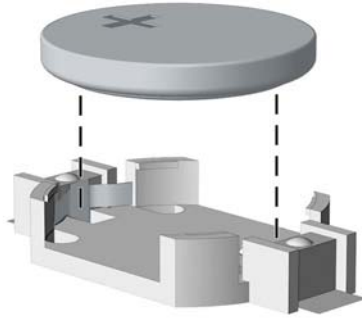

- b. Slide the replacement battery into position, positive side up. The battery holder automatically secures the battery in the proper position.

**Type 2**

- a. To release the battery from its holder, squeeze the metal clamp that extends above one edge of the battery. When the battery pops up, lift it out (1).
- b. To insert the new battery, slide one edge of the replacement battery under the lip of the holder with the positive side up. Push the other edge down until the clamp snaps over the other edge of the battery (2).

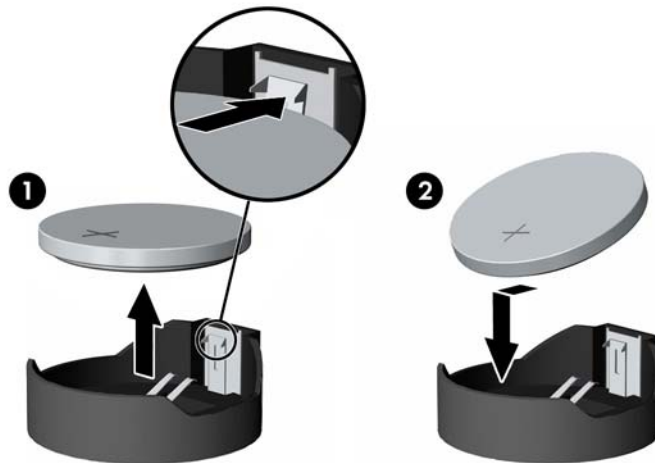

**Type 3**

- a. Pull back on the clip (1) that is holding the battery in place, and remove the battery (2).

- b. Insert the new battery and position the clip back into place.

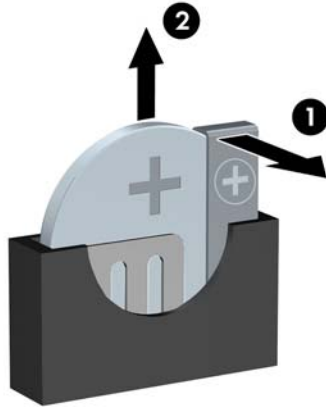

---

 **NOTE:** After the battery has been replaced, use the following steps to complete this procedure.

8. Replace the computer access panel.
9. Reconnect the power cord and any external devices, and then turn on the computer.
10. Reset the date and time, your passwords, and any special system setups using Computer Setup.
11. Lock any security devices that were disengaged when the computer access panel was removed.

---

## B Electrostatic discharge

A discharge of static electricity from a finger or other conductor may damage system boards or other static-sensitive devices. This type of damage may reduce the life expectancy of the device.

### Preventing electrostatic damage

To prevent electrostatic damage, observe the following precautions:

- Avoid hand contact by transporting and storing products in static-safe containers.
- Keep electrostatic-sensitive parts in their containers until they arrive at static-free workstations.
- Place parts on a grounded surface before removing them from their containers.
- Avoid touching pins, leads, or circuitry.
- Always be properly grounded when touching a static-sensitive component or assembly.

### Grounding methods

There are several methods for grounding. Use one or more of the following methods when handling or installing electrostatic-sensitive parts:

- Use a wrist strap connected by a ground cord to a grounded workstation or computer chassis. Wrist straps are flexible straps with a minimum of 1 megohm +/- 10 percent resistance in the ground cords. To provide proper ground, wear the strap snug against the skin.
- Use heelstraps, toestraps, or bootstraps at standing workstations. Wear the straps on both feet when standing on conductive floors or dissipating floor mats.
- Use conductive field service tools.
- Use a portable field service kit with a folding static-dissipating work mat.

If you do not have any of the suggested equipment for proper grounding, contact an HP authorized dealer, reseller, or service provider.



**NOTE:** For more information on static electricity, contact an HP authorized dealer, reseller, or service provider.

---

---

# C Computer operating guidelines, routine care and shipping preparation

## Computer operating guidelines and routine care

Follow these guidelines to properly set up and care for the computer and monitor:

- Keep the computer away from excessive moisture, direct sunlight, and extremes of heat and cold.
- Operate the computer on a sturdy, level surface. Leave a 10.2-cm (4-inch) clearance on all vented sides of the computer and above the monitor to permit the required airflow.
- Never restrict the airflow into the computer by blocking any vents or air intakes. Do not place the keyboard, with the keyboard feet down, directly against the front of the desktop unit as this also restricts airflow.
- Never operate the computer with the access panel or any of the expansion card slot covers removed.
- Do not stack computers on top of each other or place computers so near each other that they are subject to each other's re-circulated or preheated air.
- If the computer is to be operated within a separate enclosure, intake and exhaust ventilation must be provided on the enclosure, and the same operating guidelines listed above will still apply.
- Keep liquids away from the computer and keyboard.
- Never cover the ventilation slots on the monitor with any type of material.
- Install or enable power management functions of the operating system or other software, including sleep states.
- Turn off the computer before you do either of the following:
  - Wipe the exterior of the computer with a soft, damp cloth as needed. Using cleaning products may discolor or damage the finish.
  - Occasionally clean the air vents on all vented sides of the computer. Lint, dust, and other foreign matter can block the vents and limit the airflow.

# Optical drive precautions

Be sure to observe the following guidelines while operating or cleaning the optical drive.

## Operation

- Do not move the drive during operation. This may cause it to malfunction during reading.
- Avoid exposing the drive to sudden changes in temperature, as condensation may form inside the unit. If the temperature suddenly changes while the drive is on, wait at least one hour before you turn off the power. If you operate the unit immediately, it may malfunction while reading.
- Avoid placing the drive in a location that is subject to high humidity, extreme temperatures, mechanical vibration, or direct sunlight.

## Cleaning

- Clean the panel and controls with a soft, dry cloth or a soft cloth lightly moistened with a mild detergent solution. Never spray cleaning fluids directly on the unit.
- Avoid using any type of solvent, such as alcohol or benzene, which may damage the finish.

## Safety

If any object or liquid falls into the drive, immediately unplug the computer and have it checked by an authorized HP service provider.

## Shipping preparation

Follow these suggestions when preparing to ship the computer:

1. Back up the hard drive files to an external storage device. Be sure that the backup media is not exposed to electrical or magnetic impulses while stored or in transit.



---

**NOTE:** The hard drive locks automatically when the system power is turned off.

---

2. Remove and store all removable media.
3. Turn off the computer and external devices.
4. Disconnect the power cord from the electrical outlet, then from the computer.
5. Disconnect the system components and external devices from their power sources, then from the computer.



---

**NOTE:** Ensure that all boards are seated properly and secured in the board slots before shipping the computer.

---

6. Pack the system components and external devices in their original packing boxes or similar packaging with sufficient packing material to protect them.

---

## D Accessibility

HP designs, produces, and markets products and services that can be used by everyone, including people with disabilities, either on a stand-alone basis or with appropriate assistive devices.

### Supported assistive technologies

HP products support a wide variety of operating system assistive technologies and can be configured to work with additional assistive technologies. Use the Search feature on your device to locate more information about assistive features.

---

 **NOTE:** For additional information about a particular assistive technology product, contact customer support for that product.

---

### Contacting support

We are constantly refining the accessibility of our products and services and welcome feedback from users. If you have an issue with a product or would like to tell us about accessibility features that have helped you, please contact us at (888) 259-5707, Monday through Friday, 6 a.m. to 9 p.m. Mountain Time. If you are deaf or hard-of-hearing and use TRS/VRS/WebCapTel, contact us if you require technical support or have accessibility questions by calling (877) 656-7058, Monday through Friday, 6 a.m. to 9 p.m. North American Mountain Time.

---

 **NOTE:** Support is in English only.

---

---

# Index

## A

access panel  
    removal 6  
    replacement 7  
accessibility 40

## B

battery replacement 34

## C

computer operating guidelines 38

## D

DIMMs. *See* memory  
drives  
    cable connections 19  
    installation 19  
    locations 18

## E

electrostatic discharge, preventing  
    damage 37  
expansion card  
    installation 14  
    removal 14

## F

front bezel  
    blank removal 9  
    removal 8  
    replacement 9  
front panel components 2

## H

hard drive  
    2.5-inch installation 26  
    2.5-inch removal 25  
    3.5-inch installation 24  
    3.5-inch removal 23

## I

installation guidelines 5  
installing  
    2.5-inch hard drive 26  
    3.5-inch hard drive 24

battery 34  
computer access panel 7  
drive cables 19  
expansion card 14  
memory 11  
optical drive 21

## L

locks  
    cable lock 28  
    HP Business PC Security Lock 29  
    padlock 28

## M

memory  
    installation 11  
    socket population 11  
    specifications 11

## O

optical drive  
    cleaning 39  
    installation 21  
    precautions 39  
    removal 20

## P

product ID location 4

## R

rear panel components 3  
removing  
    2.5-inch hard drive 25  
    3.5-inch hard drive 23  
    battery 34  
    bezel blank 9  
    computer access panel 6  
    expansion card 14  
    front bezel 8  
    optical drive 20

## S

security  
    cable lock 28

HP Business PC Security Lock 29

    padlock 28  
serial number location 4  
shipping preparation 39  
system board connections 10

## V

ventilation guidelines 38