



msi[™]

B75MA-P45 series

MS-7798 (v1.x) Mainboard

Copyright Notice

The material in this document is the intellectual property of **MICRO-STAR INTERNATIONAL**. We take every care in the preparation of this document, but no guarantee is given as to the correctness of its contents. Our products are under continual improvement and we reserve the right to make changes without notice.

Trademarks

All trademarks in this manual are properties of their respective owners.

- MSI® is registered trademark of Micro-Star Int'l Co.,Ltd.
- NVIDIA® is registered trademark of NVIDIA Corporation.
- ATI® is registered trademark of AMD Corporation.
- AMD® is registered trademarks of AMD Corporation.
- Intel® is registered trademarks of Intel Corporation.
- Windows® is registered trademarks of Microsoft Corporation.
- AMI® is registered trademark of American Megatrends Inc.
- Award® is a registered trademark of Phoenix Technologies Ltd.
- Sound Blaster® is registered trademark of Creative Technology Ltd.
- Realtek® is registered trademark of Realtek Semiconductor Corporation.
- JMicon® is registered trademark of JMicon Technology Corporation.
- Netware® is a registered trademark of Novell, Inc.
- Lucid® is trademarks of LucidLogix Technologies, Ltd.
- VIA® is registered trademark of VIA Technologies, Inc.
- ASMedia® is registered trademark of ASMedia Technology Inc.
- iPad, iPhone, and iPod are trademarks of Apple Inc.

Revision History

Revision	Revision History	Date
V1.0	First release for PCB 1.X	2012/ 03

Technical Support

If a problem arises with your system and no solution can be obtained from the user's manual, please contact your place of purchase or local distributor. Alternatively, please try the following help resources for further guidance.

- ☐ Visit the MSI website for technical guide, BIOS updates, driver updates, and other information: <http://www.msi.com/service/download>
- ☐ Contact our technical staff at: <http://support.msi.com>

Safety Instructions

- Always read the safety instructions carefully.
- Keep this User's Manual for future reference.
- Keep this equipment away from humidity.
- Lay this equipment on a reliable flat surface before setting it up.
- The openings on the enclosure are for air convection hence protects the equipment from overheating. **DO NOT COVER THE OPENINGS.**
- Make sure the voltage of the power source is at 110/220V before connecting the equipment to the power inlet.
- Place the power cord such a way that people can not step on it. Do not place anything over the power cord.
- Always Unplug the Power Cord before inserting any add-on card or module.
- All cautions and warnings on the equipment should be noted.
- Never pour any liquid into the opening that can cause damage or cause electrical shock.
- If any of the following situations arises, get the equipment checked by service personnel:
 - The power cord or plug is damaged.
 - Liquid has penetrated into the equipment.
 - The equipment has been exposed to moisture.
 - The equipment does not work well or you can not get it work according to User's Manual.
 - The equipment has been dropped and damaged.
 - The equipment has obvious sign of breakage.
- **DO NOT LEAVE THIS EQUIPMENT IN AN ENVIRONMENT ABOVE 60°C (140°F), IT MAY DAMAGE THE EQUIPMENT.**

FCC-B Radio Frequency Interference Statement

This equipment has been tested and found to comply with the limits for a Class B digital device, pursuant to Part 15 of the FCC Rules. These limits are designed to provide reasonable protection against



harmful interference in a residential installation. This equipment generates, uses and can radiate radio frequency energy and, if not installed and used in accordance with the instructions, may cause harmful interference to radio communications. However, there is no guarantee that interference will not occur in a particular installation. If this equipment does cause harmful interference to radio or television reception, which can be determined by turning the equipment off and on, the user is encouraged to try to correct the interference by one or more of the measures listed below.

- Reorient or relocate the receiving antenna.
- Increase the separation between the equipment and receiver.
- Connect the equipment into an outlet on a circuit different from that to which the receiver is connected.
- Consult the dealer or an experienced radio/television technician for help.

Notice 1

The changes or modifications not expressly approved by the party responsible for compliance could void the user's authority to operate the equipment.

Notice 2

Shielded interface cables and A.C. power cord, if any, must be used in order to comply with the emission limits.

VOIR LA NOTICE D'INSTALLATION AVANT DE RACCORDER AU RESEAU.

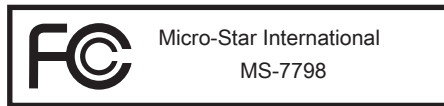

This device complies with Part 15 of the FCC Rules. Operation is subject to the following two conditions:

- 1) this device may not cause harmful interference, and
- 2) this device must accept any interference received, including interference that may cause undesired operation.

Battery Information



European Union:

Batteries, battery packs, and accumulators should not be disposed of as unsorted household waste. Please use the public collection system to return, recycle, or treat them in compliance with the local regulations.



Taiwan:

For better environmental protection, waste batteries should be collected separately for recycling or special disposal.

廢電池請回收

California, USA:

The button cell battery may contain perchlorate material and requires special handling when recycled or disposed of in California.

For further information please visit:

<http://www.dtsc.ca.gov/hazardouswaste/perchlorate/>

CAUTION: There is a risk of explosion, if battery is incorrectly replaced.

Replace only with the same or equivalent type recommended by the manufacturer.

Chemical Substances Information

In compliance with chemical substances regulations, such as the EU REACH Regulation (Regulation EC No. 1907/2006 of the European Parliament and the Council), MSI provides the information of chemical substances in products at:

http://www.msi.com/html/popup/csr/evmtprtt_pcm.html

BSMI EMI 聲明

警告使用者:

這是甲類資訊產品，在居住的環境中使用時，可能會造成無線電干擾，在這種情況下，使用者會被要求採取某些適當的對策。

WEEE (Waste Electrical and Electronic Equipment) Statement

ENGLISH

To protect the global environment and as an environmentalist, MSI must remind you that...



Under the European Union ("EU") Directive on Waste Electrical and Electronic Equipment, Directive 2002/96/EC, which takes effect on August 13, 2005, products of "electrical and electronic equipment" cannot be discarded as municipal wastes anymore, and manufacturers of covered electronic equipment will be obligated to take back such products at the end of their useful life. MSI will comply with the product take back requirements at the end of life of MSI-branded products that are sold into the EU. You can return these products to local collection points.

DEUTSCH

Hinweis von MSI zur Erhaltung und Schutz unserer Umwelt

Gemäß der Richtlinie 2002/96/EG über Elektro- und Elektronik-Altgeräte dürfen Elektro- und Elektronik-Altgeräte nicht mehr als kommunale Abfälle entsorgt werden. MSI hat europaweit verschiedene Sammel- und Recyclingunternehmen beauftragt, die in die Europäische Union in Verkehr gebrachten Produkte, am Ende seines Lebenszyklus zurückzunehmen. Bitte entsorgen Sie dieses Produkt zum gegebenen Zeitpunkt ausschliesslich an einer lokalen Altgerätesammelstelle in Ihrer Nähe.

FRANÇAIS

En tant qu'écologiste et afin de protéger l'environnement, MSI tient à rappeler ceci...

Au sujet de la directive européenne (EU) relative aux déchets des équipement électriques et électroniques, directive 2002/96/EC, prenant effet le 13 août 2005, que les produits électriques et électroniques ne peuvent être déposés dans les décharges ou tout simplement mis à la poubelle. Les fabricants de ces équipements seront obligés de récupérer certains produits en fin de vie. MSI prendra en compte cette exigence relative au retour des produits en fin de vie au sein de la communauté européenne. Par conséquent vous pouvez retourner localement ces matériels dans les points de collecte.

РУССКИЙ

Компания MSI предпринимает активные действия по защите окружающей среды, поэтому напоминаем вам, что....

В соответствии с директивой Европейского Союза (ЕС) по предотвращению загрязнения окружающей среды использованным электрическим и электронным оборудованием (директива WEEE 2002/96/ЕС), вступающей в силу 13 августа 2005 года, изделия, относящиеся к электрическому и электронному оборудованию, не могут рассматриваться как бытовой мусор, поэтому производители вышеперечисленного электронного оборудования обязаны принимать его для переработки по окончании срока службы. MSI обязуется соблюдать требования по приему продукции, проданной под маркой MSI на территории ЕС, в переработку по окончании срока службы. Вы можете вернуть эти изделия в специализированные пункты приема.

ESPAÑOL

MSI como empresa comprometida con la protección del medio ambiente, recomienda: Bajo la directiva 2002/96/EC de la Unión Europea en materia de desechos y/o equipos electrónicos, con fecha de rígor desde el 13 de agosto de 2005, los productos clasificados como “eléctricos y equipos electrónicos” no pueden ser depositados en los contenedores habituales de su municipio, los fabricantes de equipos electrónicos, están obligados a hacerse cargo de dichos productos al termino de su período de vida. MSI estará comprometido con los términos de recogida de sus productos vendidos en la Unión Europea al final de su periodo de vida. Usted debe depositar estos productos en el punto limpio establecido por el ayuntamiento de su localidad o entregar a una empresa autorizada para la recogida de estos residuos.

NEDERLANDS

Om het milieu te beschermen, wil MSI u eraan herinneren dat...

De richtlijn van de Europese Unie (EU) met betrekking tot Vervuiling van Electriche en Electronische producten (2002/96/EC), die op 13 Augustus 2005 in zal gaan kunnen niet meer beschouwd worden als vervuiling. Fabrikanten van dit soort producten worden verplicht om producten retour te nemen aan het eind van hun levenscyclus. MSI zal overeenkomstig de richtlijn handelen voor de producten die de merknaam MSI dragen en verkocht zijn in de EU. Deze goederen kunnen geretourneerd worden op lokale inzamelingspunten.

SRPSKI

Da bi zaštitili prirodnu sredinu, i kao preduzeće koje vodi računa o okolini i prirodnoj sredini, MSI mora da vas podesti da...

Po Direktivi Evropske unije (“EU”) o odbačenju eelektronskoj i električnoj opremi, Direktiva 2002/96/EC, koja stupa na snagu od 13. Avgusta 2005, proizvodi koji spadaju pod “elektronsku i električnu opremu” ne mogu više biti odbačeni kao običan otpad i proizvođači ove opreme biće prinuđeni da uzmu natrag ove proizvode na kraju njihovog uobičajenog veka trajanja. MSI će poštovati zahtev o preuzimanju ovakvih proizvoda kojima je istekao vek trajanja, koji imaju MSI oznaku i koji su prodati u EU. Ove proizvode možete vratiti na lokalnim mestima za prikupljanje.

POLSKI

Aby chronić nasze środowisko naturalne oraz jako firma dbająca o ekologię, MSI przypomina, że...

Zgodnie z Dyrektywą Unii Europejskiej (“UE”) dotyczącą odpadów produktów elektrycznych i elektronicznych (Dyrektywa 2002/96/EC), która wchodzi w życie 13 sierpnia 2005, tzw. “produkty oraz wyposażenie elektryczne i elektroniczne” nie mogą być traktowane jako śmieci komunalne, tak więc producenci tych produktów będą zobowiązani do odbierania ich w momencie gdy produkt jest wycofywany z użycia. MSI wypełni wymagania UE, przyjmując produkty (sprzedawane na terenie Unii Europejskiej) wycofywane z użycia. Produkty MSI będzie można zwracać w wyznaczonych punktach zbiorczych.

TÜRKÇE

Çevreci özelliğiyle bilinen MSI dünyada çevreyi korumak için hatırlatır:

Avrupa Birliği (AB) Kararnamesi Elektrik ve Elektronik Malzeme Atığı, 2002/96/EC Kararnamesi altında 13 Ağustos 2005 tarihinden itibaren geçerli olmak üzere, elektrikli ve elektronik malzemeler diğer atıklar gibi çöpe atılmayacak ve bu elektronik cihazların üreticileri, cihazların kullanım süreleri bittikten sonra ürünleri geri toplamakla yükümlü olacaktır. Avrupa Birliği'ne satılan MSI markalı ürünlerin kullanım süreleri bittiğinde MSI ürünlerin geri alınması isteği ile işbirliği içerisinde olacaktır. Ürünlerinizi yerel toplama noktalarına bırakabilirsiniz.

ČESKY

Záleží nám na ochraně životního prostředí - společnost MSI upozorňuje...

Podle směrnice Evropské unie ("EU") o likvidaci elektrických a elektronických výrobků 2002/96/EC platné od 13. srpna 2005 je zakázáno likvidovat "elektrické a elektronické výrobky" v běžném komunálním odpadu a výrobci elektrických výrobků, na které se tato směrnice vztahuje, budou povinni odebírat takové výrobky zpět po skončení jejich životnosti. Společnost MSI splní požadavky na odebírání výrobků značky MSI, prodávaných v zemích EU, po skončení jejich životnosti. Tyto výrobky můžete odevzdat v místních sběrnách.

MAGYAR

Annak érdekében, hogy környezetünket megvédjük, illetve környezetvédőként fellépve az MSI emlékezteti Önt, hogy ...

Az Európai Unió („EU”) 2005. augusztus 13-án hatályba lépő, az elektromos és elektronikus berendezések hulladékairól szóló 2002/96/EK irányelve szerint az elektromos és elektronikus berendezések többé nem kezelhetőek lakossági hulladékként, és az ilyen elektronikus berendezések gyártói köteleessé válnak az ilyen termékek visszavételére azok hasznos élettartama végén. Az MSI betartja a termékvisszavétellel kapcsolatos követelményeket az MSI márkánév alatt az EU-n belül értékesített termékek esetében, azok élettartamának végén. Az ilyen termékeket a legközelebbi gyűjtőhelyre viheti.

ITALIANO

Per proteggere l'ambiente, MSI, da sempre amica della natura, ti ricorda che....

In base alla Direttiva dell'Unione Europea (EU) sullo Smaltimento dei Materiali Elettrici ed Elettronici, Direttiva 2002/96/EC in vigore dal 13 Agosto 2005, prodotti appartenenti alla categoria dei Materiali Elettrici ed Elettronici non possono più essere eliminati come rifiuti municipali: i produttori di detti materiali saranno obbligati a ritirare ogni prodotto alla fine del suo ciclo di vita. MSI si adegnerà a tale Direttiva ritirando tutti i prodotti marchiati MSI che sono stati venduti all'interno dell'Unione Europea alla fine del loro ciclo di vita. È possibile portare i prodotti nel più vicino punto di raccolta

CONTENTS

Copyright Notice	ii
Trademarks	ii
Revision History.....	ii
Technical Support.....	iii
Safety Instructions	iii
FCC-B Radio Frequency Interference Statement.....	iv
Battery Information	v
Chemical Substances Information.....	v
BSMI EMI 聲明	v
WEEE (Waste Electrical and Electronic Equipment) Statement	vi
Chapter 1 Getting Started.....	1-1
Packing Contents	1-2
Optional Accessories	1-2
Assembly Precautions.....	1-3
Mainboard Specifications	1-4
Connectors Quick Guide.....	1-6
Back Panel Quick Guide	1-8
CPU (Central Processing Unit)	1-10
Mounting Screw Holes	1-14
Power Supply	1-15
Memory	1-16
Expansion Slots	1-18
Video/ Graphics Cards	1-19
Internal Connectors.....	1-20
Jumper	1-27
Chapter 2 BIOS Setup.....	2-1
Entering.....	2-2
Overview	2-2
Boot device priority bar	2-3
Operation	2-4
SETTINGS	2-5
OC.....	2-11
ECO	2-17
BROWSER.....	2-18
Installing Winki	2-18
Updating the BIOS with Live Update.....	2-19

UTILITIES	2-20
SECURITY	2-22
Appendix A Realtek Audio.....	A-1
Installing the Realtek HD Audio Driver.....	A-2
Software Configuration.....	A-3
Appendix B Intel SBA.....	B-1
Prerequisites	B-2
Installing Intel SBA.....	B-3
Software Configuration.....	B-3
Help Button	B-4

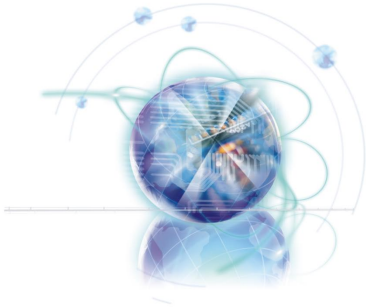

Chapter 1

Getting Started

Thank you for choosing the **B75MA-P45 Series (MS-7798 v1.X)** Micro-ATX mainboard. The Series mainboards are based on **Intel® B75** chipset for optimal system efficiency. Designed to fit the advanced **Intel® LGA1155** processor, the **B75MA-P45 Series** mainboards deliver a high performance and professional desktop platform solution.

Packing Contents

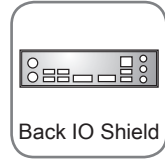
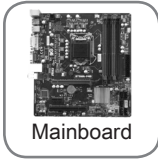

Optional Accessories



* These pictures are for reference only and may vary without notice.

* The packing contents may vary according to the model you purchased.

* If you need to purchase the optional accessories or request part numbers, please visit the MSI website at <http://www.msi.com/index.php> or consult the dealer.

Assembly Precautions

- The components included in this package are prone to damage from electrostatic discharge (ESD). Please adhere to the following instructions to ensure successful computer assembly.
- Always turn off the power supply and unplug the power cord from the power outlet before installing or removing any computer component.
- Ensure that all components are securely connected. Loose connections may cause the computer to not recognize a component or fail to start.
- Hold the mainboard by the edges to avoid touching sensitive components.
- It is recommended to wear an electrostatic discharge (ESD) wrist strap when handling the mainboard to prevent electrostatic damage. If an ESD wrist strap is not available, discharge yourself of static electricity by touching another metal object before handling the mainboard.
- Store the mainboard in an electrostatic shielding container or on an antistatic pad whenever the mainboard is not installed.
- Before turning on the computer, ensure that there are no loose screws or metal components on the mainboard or anywhere within the computer case.
- Do not use the computer in a high-temperature environment.
- Do not boot the computer before installation is completed. This could cause permanent damage to the components as well as injury to the user.
- If you need help during any installation step, please consult a certified computer technician.

Important

A screwdriver (not included) may be required for computer assembly.

Mainboard Specifications

Processor Support

- Support 3rd Generation Intel® Core™ i7/ Core™ i5/ Core™ i3/ Pentium®/ Celeron® Processors for LGA 1155 socket
(For the latest information about CPU, please visit <http://www.msi.com/service/cpu-support>)

Chipset

- Intel® B75 chipset
 - Supports Intel SBA

Memory Support

- 4x DDR3 DIMMs support DDR3 1600/ 1333/ 1066 DRAM (32GB Max.)
- Supports Dual-Channel mode, two DIMMs per channel
(For the latest information about memory, please visit <http://www.msi.com/service/test-report>)

LAN

- Supports LAN 10/100/1000 Fast Ethernet by Realtek® RTL8111E

Audio

- Integrated HD audio codec by Realtek® ALC887
- Flexible 8-channel audio with jack sensing

SATA

- 1x SATA 6Gb/s port (SATA1) by Intel® B75
- 5x SATA 3Gb/s ports (SATA2~6) by Intel® B75

USB 3.0

- 2x USB 3.0 rear IO ports by Intel® B75
- 1x USB 3.0 onboard connector by Intel® B75

Connectors

- Back panel
 - 1x PS/2 keyboard port
 - 1x PS/2 mouse port
 - 4x USB 2.0 ports
 - 2x USB 3.0 ports
 - 1x LAN port
 - 1x VGA port**
 - 1x DVI-D port**, supporting a maximum resolution of 1920x1200
 - 3x audio ports
- (**This mainboard supports dual-display function).
- On-Board
 - 1x Front Panel Audio connector
 - 1x Parallel Port connector
 - 2x USB 2.0 connectors
 - 1x USB 3.0 connector
 - 1x Chassis Intrusion connector
 - 1x Serial Port connector
 - 1x TPM Module connector

Slots

- 1x PCIe 3.0 x16 slot
- 1x PCIe 2.0 x1 slot
- 1x PCI slot

Form Factor

- Micro-ATX (22.5 cm X 24.4 cm)

Mounting Screw Holes

- 6x mounting holes

Connectors Quick Guide

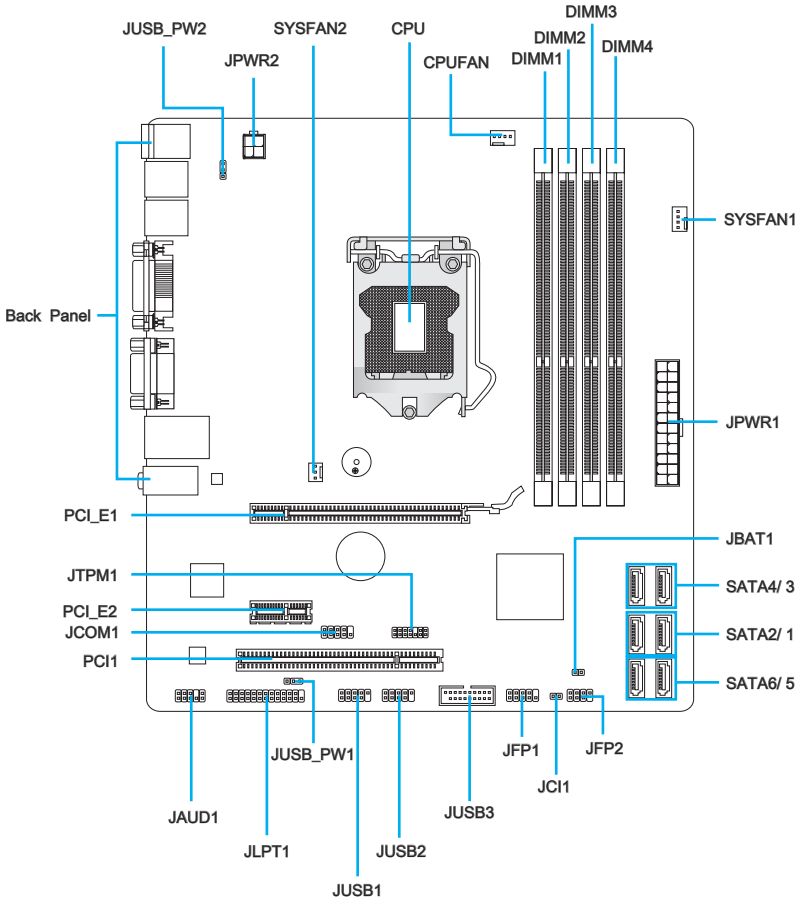

Connectors Reference Guide

Port Name	Port Type	Page
Back Panel		1-8
CPU	LGA 1155 CPU Socket	1-10
CPUFAN,SYSFAN1~2	Fan Power Connectors	1-21
DIMM1~4	DDR3 Memory Slots	1-16
JAUD1	Front Panel Audio Connector	1-25
JBAT1	Clear CMOS Jumper	1-28
JCI1	Chassis Intrusion Connector	1-24
JCOM1	Serial Port Connector	1-26
JFP1, JFP2	Front Panel Connectors	1-22
JLPT1	Parallel Port Connector	1-26
JPWR1	ATX 24-pin Power Connector	1-15
JPWR2	ATX 4-pin Power Connector	1-15
JTPM1	TPM Module Connector	1-25
JUSB_PW1~2	USB power Jumper	1-27
JUSB1~2	USB 2.0 Expansion Connectors	1-24
JUSB3	USB 3.0 Expansion Connector	1-23
PCI1	PCI Expansion Slot	1-18
PCI_E1	PCIe x16 Expansion Slot	1-18
PCI_E2	PCIe x1 Expansion Slot	1-18
SATA1	SATA 6Gb/s Connector	1-20
SATA2~6	SATA 3Gb/s Connector	1-20

Back Panel Quick Guide

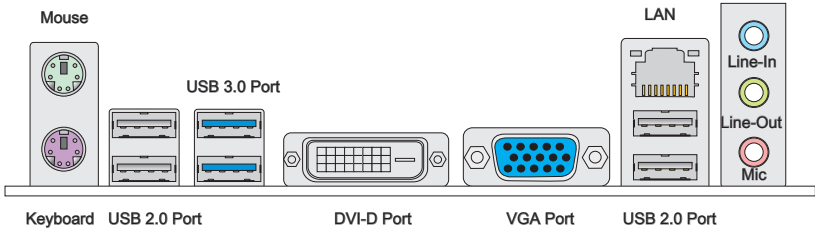

▶ Mouse/Keyboard

The standard PS/2® mouse/keyboard DIN connector is for a PS/2® mouse/keyboard.

▶ USB 2.0 Port

The USB 2.0 port is for attaching USB 2.0 devices such as keyboard, mouse, or other USB 2.0-compatible devices.

▶ USB 3.0 Port

USB 3.0 port is backward-compatible with USB 2.0 devices. It supports data transfer rate up to 5 Gbit/s (SuperSpeed).

Important

In order to use USB 3.0 devices, you must connect to a USB 3.0 port. If a USB cable is used, it must be USB 3.0 compliant.

▶ DVI-D Port

The DVI-D (Digital Visual Interface- Digital) connector can be connected to a LCD monitor, or a CRT monitor with an adapter. To connect a monitor, please refer to the monitor's manual for more information.

▶ VGA Port

The DB15-pin female connector is provided for monitor.

Important

This platform supports dual-display function.

	DVI+VGA
Extend mode (Extend the desktop to the second monitor)	○
Clone mode (Two monitors have the same screen)	○

► LAN

The standard RJ-45 LAN jack is for connecting to a Local Area Network (LAN).

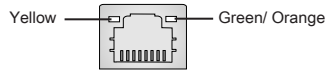

LED	Color	LED State	Condition
Left	Yellow	Off	LAN link is not established.
		On(Steady)	LAN link is established.
		On(flashing)	The computer is communicating with another computer on the network.
Right	Green	Off	10 Mbits/sec data rate
		On	100 Mbits/sec data rate
	Orange	On	1000 Mbits/sec data rate

► Audio Ports

These connectors are used for audio devices. The color of the jack refers to the function of the connector.

- Blue-Line in: Used for connecting external audio outputting devices.
- Green- Line out: Used as a connector for speakers or headphone.
- Pink- Mic: Used as a connector for a microphone.

Important

To achieve the 8-channel sound effect, the front audio panel output should be used for the 7th and 8th channels.

CPU (Central Processing Unit)

Introduction to the LGA 1155 CPU

The surface of the LGA 1155 CPU has two alignment keys and a yellow triangle to assist in correctly lining up the CPU for mainboard placement. The yellow triangle is the Pin 1 indicator.

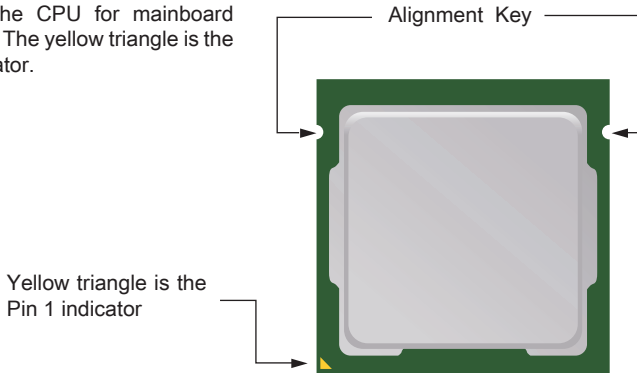

Important

Overheating

Overheating can seriously damage the CPU and mainboard. Always make sure the cooling fans work properly to protect the CPU from overheating. Be sure to apply an even layer of thermal paste (or thermal tape) between the CPU and the heatsink to enhance heat dissipation.

Replacing the CPU

When replacing the CPU, always turn off the system's power supply and unplug the power supply's power cord to ensure the safety of the CPU.

Overclocking

This mainboard is designed to support overclocking. Before attempting to overclock, please make sure that all other system components can tolerate overclocking. Any attempt to operate beyond product specifications is not recommend. MSI does not guarantee the damages or risks caused by inadequate operation beyond product specifications.

CPU & Cooler Installation

When installing a CPU, always remember to install a CPU cooler. A CPU cooler is necessary to prevent overheating and maintain system stability. Follow the steps below to ensure correct CPU and CPU cooler installation. Wrong installation can damage both the CPU and the mainboard.

1. Unhook and lift the loading lever to the fully open position.
2. The loading plate should automatically lift up as the loading lever is pushed to the fully open position. **Do not touch any of the CPU socket pins.**

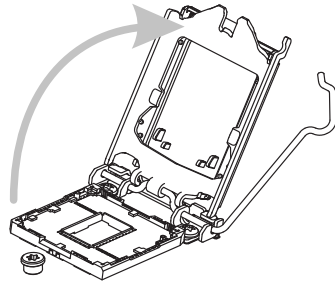
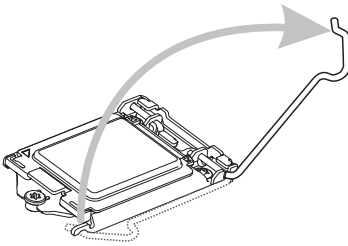

3. Line up the CPU to fit the CPU socket. Be sure to hold the CPU by the base with the metal contacts facing downward. The alignment keys on the CPU will line up with the edges of the CPU socket to ensure a correct fit.
4. Close the loading plate and remove the plastic protective cap.

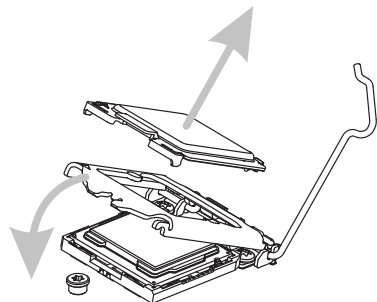
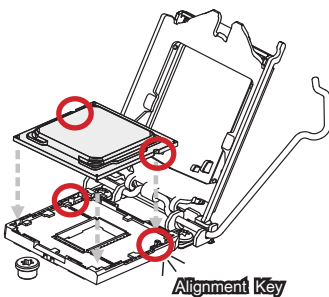

5. Inspect the CPU to check if it is properly seated in the socket. Press the loading lever down and lock it under the retention tab.

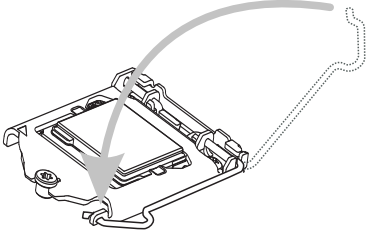

6. Evenly spread a thin layer of thermal paste (or thermal tape) on the top of the CPU. This will help in heat dissipation and prevent CPU overheating.

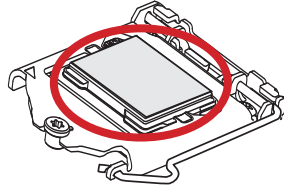

7. Locate the CPU fan connector on the mainboard.

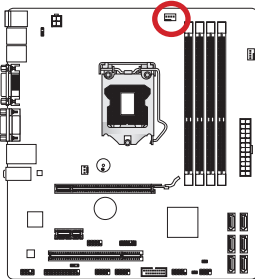

8. Place the heatsink on the mainboard with the fan's wires facing towards the fan connector and the hooks matching the holes on the mainboard.

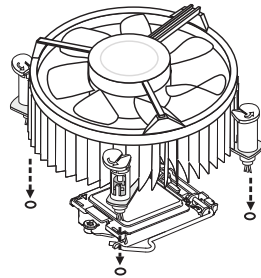

9. Push down on the heatsink until the four clips get wedged into the holes on the mainboard. Press the four hooks down to fasten the cooler. As each hook locks into position a click should be heard.
10. Inspect the mainboard to ensure that the clip-ends have been properly locked in place.

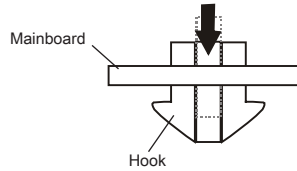
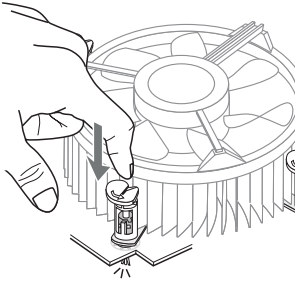

11. Finally, attach the CPU fan cable to the CPU fan connector on the mainboard.

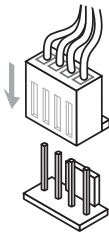

Important

- Do not touch the CPU socket pins.
- Confirm that the CPU cooler has formed a tight seal with the CPU before booting your system.
- Whenever the CPU is not installed, always protect the CPU socket pins by covering the socket with the plastic cap.
- Please refer to the documentation in the CPU cooler package for more details about CPU cooler installation.

Mounting Screw Holes

When installing the mainboard, first install the necessary mounting stands required for a mainboard on the mounting plate in your computer case. If there is an I/O back plate that came with the computer case, please replace it with the I/O backplate that came with the mainboard package. The I/O backplate should snap easily into the computer case without the need for any screws. Align the mounting plate's mounting stands with the screw holes on the mainboard and secure the mainboard with the screws provided with your computer case. The locations of the screw holes on the mainboard are shown below. For more information, please refer to the manual that came with the computer case.

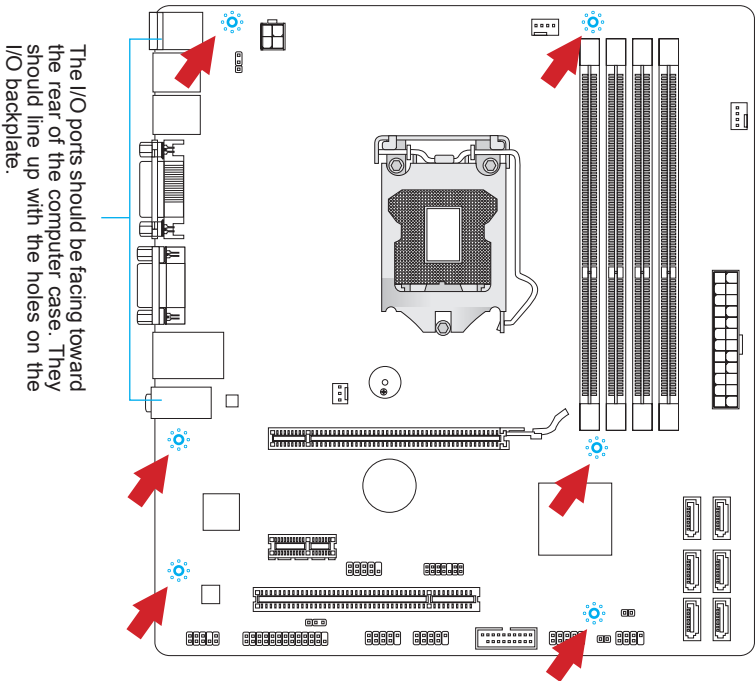

Important

- Install the mainboard on a flat surface free from unnecessary debris.
- To prevent damage to the mainboard, any contact between the mainboard circuitry and the computer case, except for the mounting stands, is prohibited.
- Please make sure there are no loose metal components on the mainboard or within the computer case that may cause a short circuit of the mainboard.

Power Supply

JPWR1: ATX 24-pin Power Connector

This connector allows you to connect an ATX 24-pin power supply. To connect the ATX 24-pin power supply, align the power supply cable with the connector and firmly press the cable into the connector. If done correctly, the clip on the power cable should be hooked on the mainboard's power connector.

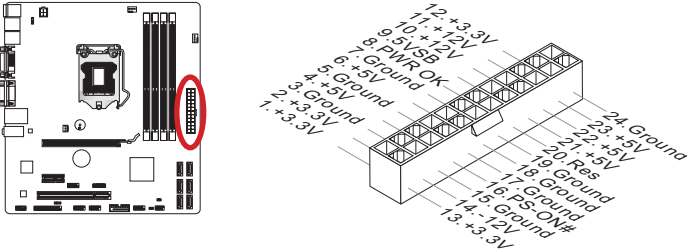

JPWR2: ATX 4-pin Power Connector

This connector provides 12V power to the CPU.

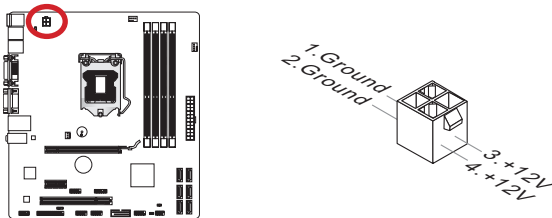

Important

Make sure that all the power cables are securely connected to a proper ATX power supply to ensure stable operation of the mainboard.

Memory

These DIMM slots are used for installing memory modules. For more information on compatible components, please visit <http://www.msi.com/service/test-report>

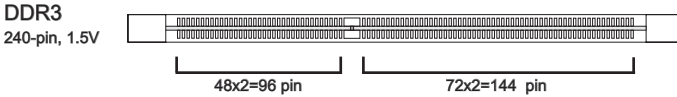

Dual-Channel mode Population Rule

In Dual-Channel mode, the memory modules can transmit and receive data with two data bus channels simultaneously. Enabling Dual-Channel mode can enhance system performance. The following illustrations explain the population rules for Dual-Channel mode.

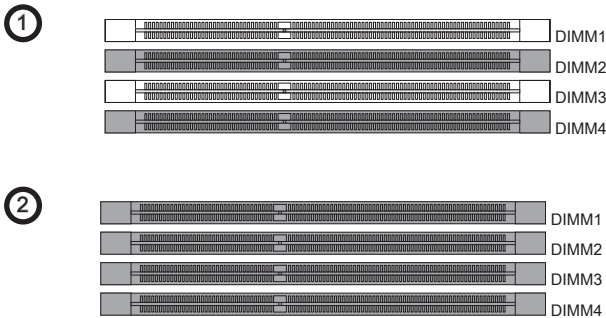

Important

- *DDR3 memory modules are not interchangeable with DDR2, and the DDR3 standard is not backward compatible. Always install DDR3 memory modules in DDR3 DIMM slots.*
- *To ensure system stability, memory modules must be of the same type and density in Dual-Channel mode.*
- *Due to chipset resource usage, the system will only detect up to 31+ GB of memory (not full 32 GB) when all DIMM slots have 8GB memory modules installed.*

Installing Memory Modules

1. Unlock the DIMM slot by pushing the mounting clips to the side. Vertically insert the memory module into the DIMM slot. The memory module has an off-center notch on the bottom that will only allow it to fit one way into the DIMM slot.
2. Push the memory module deep into the DIMM slot. The plastic clips at each side of the DIMM slot will automatically close when the memory module is properly seat and an audible click should be heard.
3. Manually check if the memory module has been locked in place by the DIMM slot's side clips.

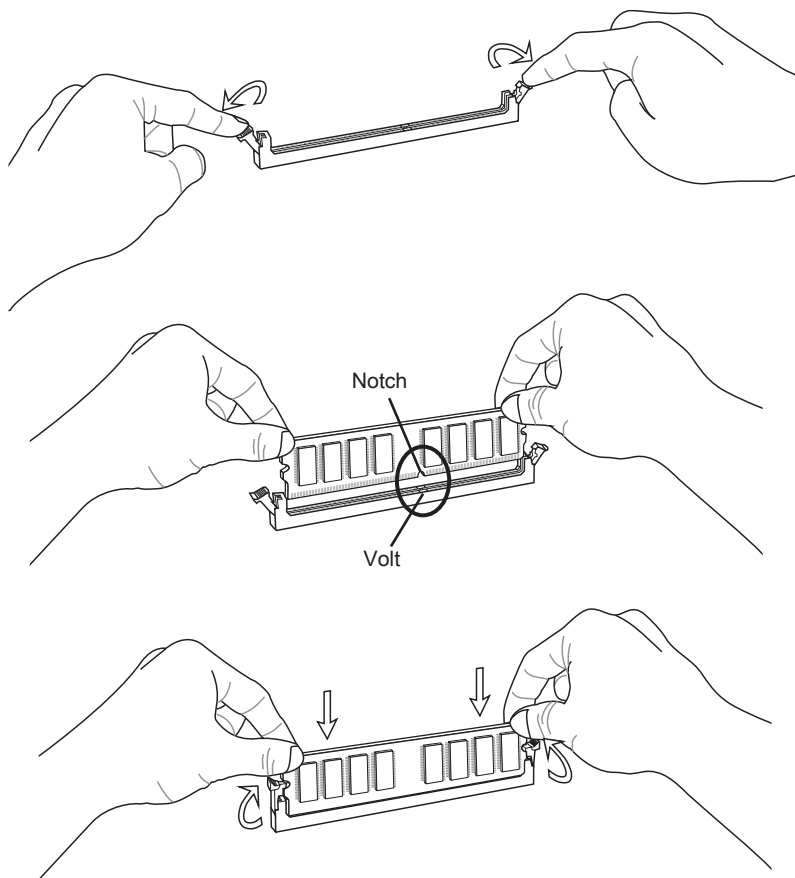

Expansion Slots

This mainboard contains numerous ports for expansion cards, such as discrete graphics or audio cards.

PCIe (Peripheral Component Interconnect Express) Slot

The PCIe slot supports the PCIe interface expansion card.

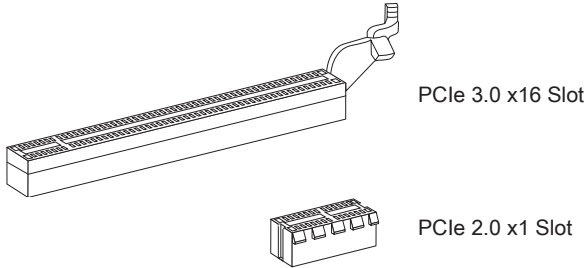

PCI (Peripheral Component Interconnect) Slot

The PCI slot supports additional LAN, SCSI, USB, and other add-on cards that comply with PCI specifications.

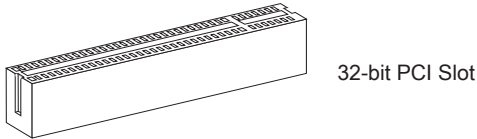

Important

When adding or removing expansion cards, always turn off the power supply and unplug the power supply power cable from the power outlet. Read the expansion card's documentation to check for any necessary additional hardware or software changes.

PCI Interrupt Request Routing

IRQ, or interrupt request lines, are hardware lines over which devices can send interrupt requests to the processor. The PCI IRQ pins are typically connected to the PCI bus pins as followed:

	Order1	Order2	Order3	Order4
PCI Slot1	INT A#	INT B#	INT C#	INT D#

Video/ Graphics Cards

If available, this mainboard takes advantage of the CPU's integrate graphics processor, but discrete video cards can be installed by way of the mainboard's expansion slots. Adding on one or more discrete video cards will significantly boost the system's graphics performance. For best compatibility, MSI graphics cards are recommended.

Single Video Card Installation

1. Determine what type of expansion slot(s) the video card will use. Locate the expansion slot(s) on the mainboard. Remove any protective expansion slot covers from the computer case.
2. Line up the video card on top of the expansion slot(s) with the display ports facing out of the computer case. For a single video card installation, using the PCI_E2 slot is recommended.
3. Push the video card into its expansion slot(s). Depending on the expansion slot(s) used, there should be clip(s) on the expansion slot(s) that will lock in place.
4. If needed, screw the edge of the graphics card to the computer case. Some video cards might require a power cable directly from the power supply.
5. Please consult your video card's manual for further instructions regarding driver installation or other special settings.

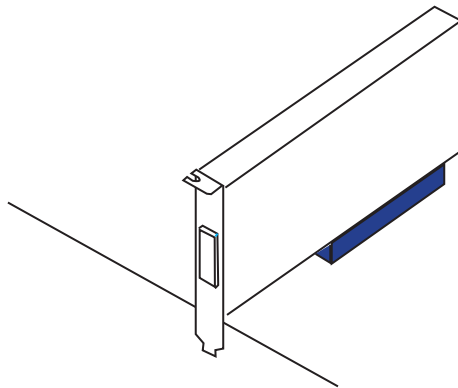

Internal Connectors

SATA1~6: SATA Connector

This connector is a high-speed SATA interface port. Each connector can connect to one SATA device. SATA devices include disk drives (HDD), solid state drives (SSD), and optical drives (CD / DVD / Blu-Ray).

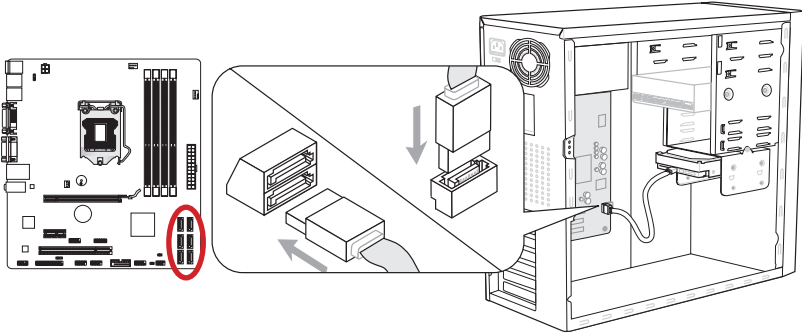

* The MB layout in this figure is for reference only.

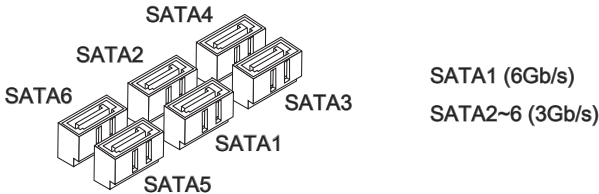

Important

- Many SATA devices also need a power cable from the power supply. Such devices include disk drives (HDD), solid state drives (SSD), and optical drives (CD / DVD / Blu-Ray). Please refer to the device's manual for further information.
- Many computer cases also require that large SATA devices, such as HDDs, SSDs, and optical drives, be screwed down into the case. Refer to the manual that came with your computer case or your SATA device for further installation instructions.
- Please do not fold the SATA cable at a 90-degree angle. Data loss may result during transmission otherwise.
- SATA cables have identical plugs on either sides of the cable. However, it is recommended that the flat connector be connected to the mainboard for space saving purposes.

CPUFAN, SYSFAN1~2: Fan Power Connectors

The fan power connectors support system cooling fans with +12V. If the mainboard has a System Hardware Monitor chipset on-board, you must use a specially designed fan with a speed sensor to take advantage of the CPU fan control. Remember to connect all system fans. Some system fans may not connect to the mainboard and will instead connect to the power supply directly. A system fan can be plugged into any available system fan connector.

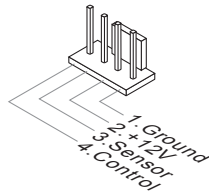
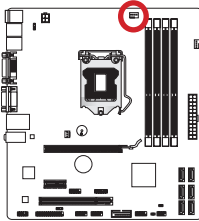

CPUFAN

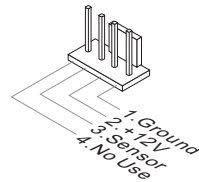
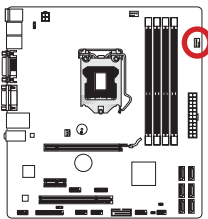

SYSFAN1

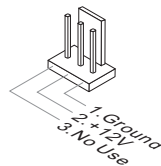
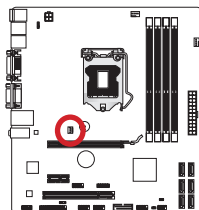

SYSFAN2

Important

- Please refer to your processor's official website or consult your vendor to find recommended CPU cooling fans.
- The CPUFAN connector supports Smart Fan Control with linear mode. The Control Center II utility can be installed to automatically control the fan speeds according to the CPU's temperature.
- If there are not enough ports on the mainboard to connect all system fans, adapters are available to connect a fan directly to a power supply.
- Before first boot up, ensure that there are no cables impeding any fan blades.

JFP1, JFP2: Front Panel Connectors

These connectors connect to the front panel switches and LEDs. The JFP1 connector is compliant with the Intel® Front Panel I/O Connectivity Design Guide. When installing the front panel connectors, please use the enclosed mConnectors to simplify installation. Plug all the wires from the computer case into the mConnectors and then plug the mConnectors into the mainboard.

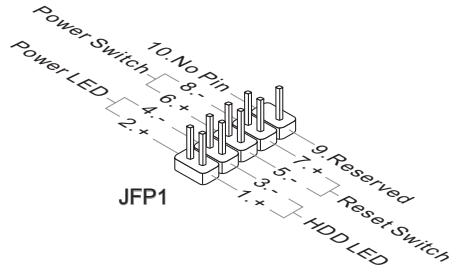
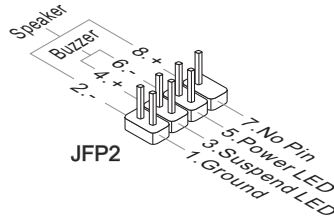
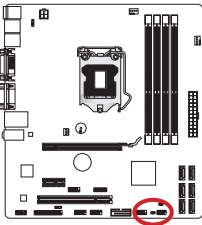

Important

- On the connectors coming from the case, pins marked by small triangles are positive wires. Please use the diagrams above and the writing on the mConnectors to determine correct connector orientation and placement.
- The majority of the computer case's front panel connectors will primarily be plugged into JFP1.

JUSB3: USB 3.0 Expansion Connector

The USB 3.0 port is backwards compatible with USB 2.0 devices. It supports data transfer rates up to 5Gbits/s (SuperSpeed).

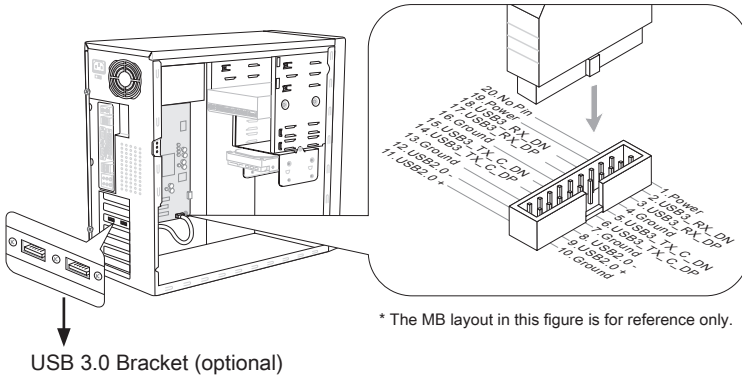
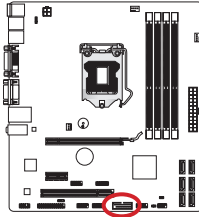

Important

- Note that the VCC and GND pins must be connected correctly to avoid possible damage.
- To use a USB 3.0 device, you must connect the device to a USB 3.0 port through an optional USB 3.0 compliant cable.

JUSB1~2: USB 2.0 Expansion Connectors

This connector is designed for connecting high-speed USB peripherals such as USB HDDs, digital cameras, MP3 players, printers, modems, and many others.

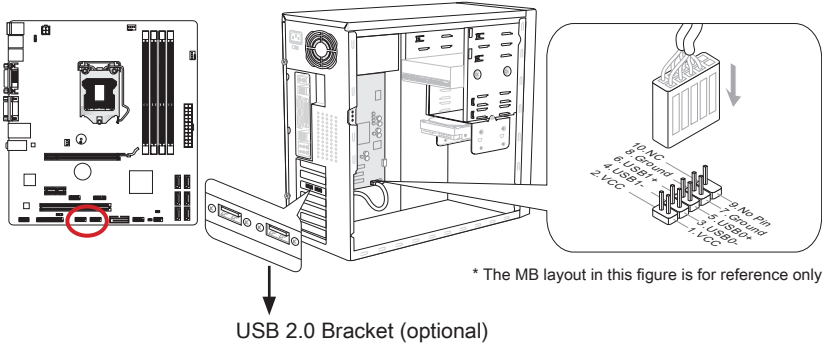

Important

Note that the VCC and GND pins must be connected correctly to avoid possible damage.

JCI1: Chassis Intrusion Connector

This connector connects to the chassis intrusion switch cable. If the computer case is opened, the chassis intrusion mechanism will be activated. The system will record this intrusion and a warning message will flash on screen. To clear the warning, you must enter the BIOS utility and clear the record.

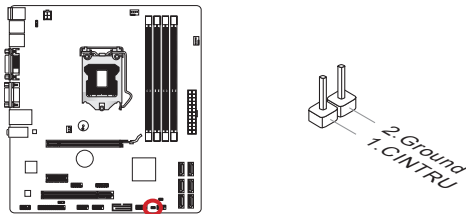

JAUD1: Front Panel Audio Connector

This connector allows you to connect the front audio panel located on your computer case. This connector is compliant with the Intel® Front Panel I/O Connectivity Design Guide.

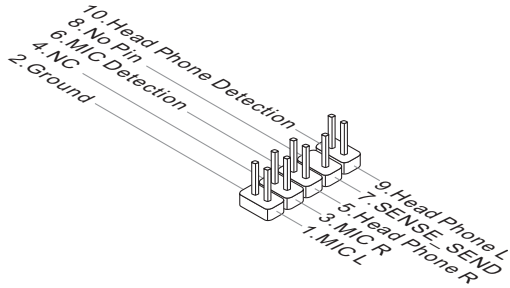
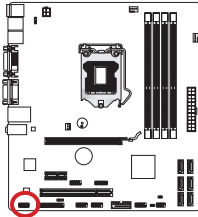

JTPM1: TPM Module Connector

This connector connects to a TPM (Trusted Platform Module). Please refer to the TPM security platform manual for more details and usages.

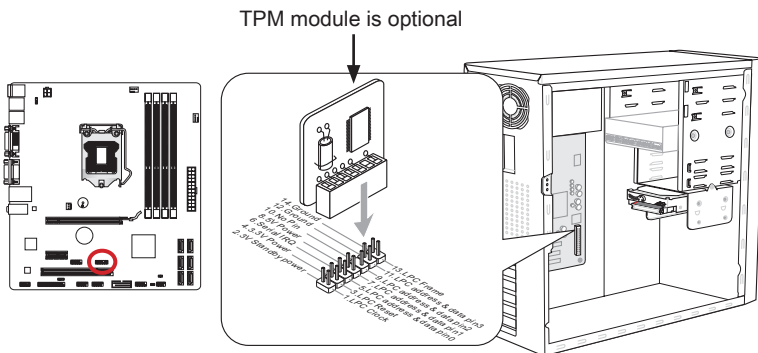

* The MB layout in this figure is for reference only.

JCOM1: Serial Port Connector

This connector is a 16550A high speed communication port that sends/receives 16 bytes FIFOs. You can attach a serial device.

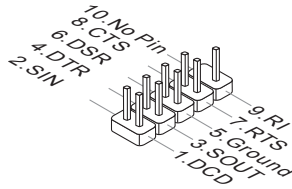
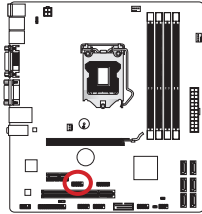

JLPT1: Parallel Port Connector

This connector is used to connect an optional parallel port bracket. The parallel port is a standard printer port that supports Enhanced Parallel Port (EPP) and Extended Capabilities Parallel Port (ECP) mode.

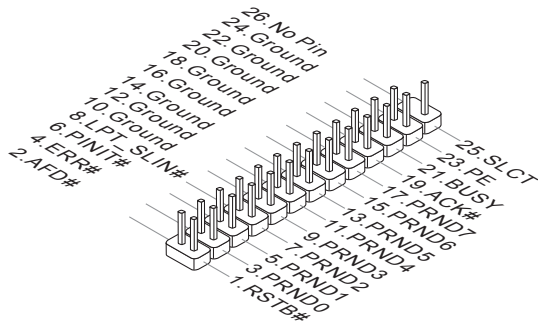
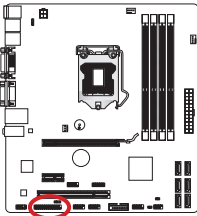

Jumper

JUSB_PW1~2: USB power Jumper

These jumpers are used to select USB ports powered by VCC5 or 5VSB. Set to 5VSB if you want them provide power in standby mode.

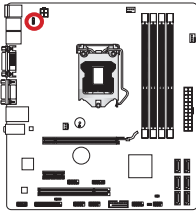

JUSB_PW1

(for on-board USB connectors)



Close 1-2

Keep USB power to VCC5 (default)



Close 2-3

Keep USB power to 5VSB

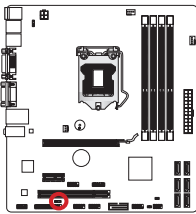

JUSB_PW2

(for back panel USB connectors)



Close 1-2

Keep USB power to VCC5 (default)



Close 2-3

Keep USB power to 5VSB

Important

If you set the jumper to 5VSB, the power supply must be able to provide at least 2A currents.

JBAT1: Clear CMOS Jumper

There is CMOS RAM onboard that is external powered from a battery located on the mainboard to save system configuration data. With the CMOS RAM, the system can automatically boot into the operating system (OS) every time it is turned on. If you want to clear the system configuration, set the jumpers to clear the CMOS RAM.

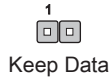
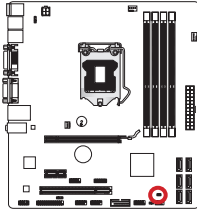

Important

You can clear the CMOS RAM by shorting this jumper while the system is off. Afterwards, open the jumper . Do not clear the CMOS RAM while the system is on because it will damage the mainboard.

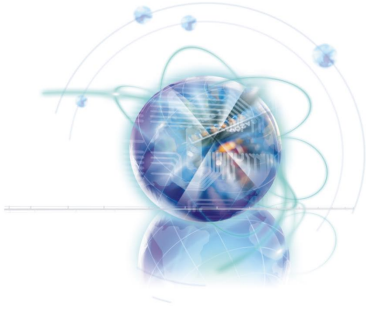

Chapter 2

BIOS Setup

CLICK BIOS II is a revolutionary UEFI interface that allows you to setup and configure your system for optimum use. Using your mouse and keyboard, users can change BIOS settings, monitor CPU temperature, select the boot device priority and view system information such as the CPU name, DRAM capacity, the OS version and the BIOS version. Users can import and export parameter data for backup or for sharing with friends. By connecting to the Internet within CLICK BIOS II, users can browse webpages, check mail and use Live Update your system.

Entering

Power on the computer and the system will start the Power On Self Test (POST) process. When the message below appears on the screen, please key to enter CLICK BIOS II:

Press DEL key to enter Setup Menu, F11 to enter Boot Menu

If the message disappears before you respond and you still need to enter CLICK BIOS II, restart the system by turning the computer OFF then back ON or pressing the RESET button. You may also restart the system by simultaneously pressing <Ctrl>, <Alt>, and <Delete> keys.

Important

The items under each BIOS category described in this chapter are under continuous update for better system performance. Therefore, the description may be slightly different from the latest BIOS and should be held for reference only.

Overview

After entering CLICK BIOS II, the following screen is displayed.



Important

The pictures in this guide are for reference only and may vary from the product you purchased. Please refer to the actual screens of your system for detailed information.

► Temperature monitor

This block shows the temperature of the processor and the mainboard.

► System information

This block shows the time, date, CPU name, CPU frequency, DRAM frequency, DRAM capacity and the BIOS version.

► BIOS menu selection

The following options are available:

- **SETTINGS** - Use this menu to specify your settings for chipset features and boot devices.
- **OC** - This menu contains items of the frequency and voltage adjustments. Increasing the frequency can get better performance, however high frequency and heat can cause instability, we do not recommend general users to over-clock.
- **ECO** - This menu is related to energy-saving settings.
- **BROWSER** - This feature is used to enter the MSI Winki web browser.
- **UTILITIES** - This menu contains utilities for backup and update.
- **SECURITY** - The security menu is used to keep unauthorized people from making any changes to the settings. You can use these security features to protect your system.

► Boot device priority bar

You can move the device icons to change the boot priority.

► Boot menu

This button is used to open a boot menu. Click the item to boot the system from the device instantly.

► Mode selection

This feature allows you to load presets of energy saving or overclocking.

► Menu display

This area provides BIOS settings and information to be configured.

Boot device priority bar

This bar shows the priority of the boot devices. The lighted icons indicate that the devices are available.

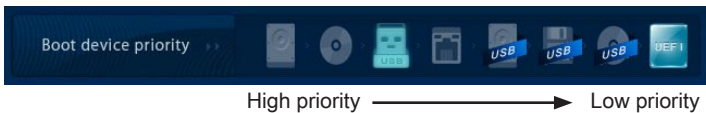

Click and draw the icon to left or right to specify the boot priority.

■ Boot device icon list



USB Drive



Hard disk drive



Optical disk



LAN



USB hard disk drive



USB floppy



USB optical drive



UEFI





BEV



Disable

Operation

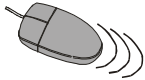
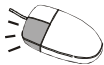
CLICK BIOS II allows you to control BIOS settings with the mouse and the keyboard. The following table lists and describes the hot keys and the mouse operations.

Hot key	Mouse	Description
<↑↓←→>	 Move the cursor	Select Item
<Enter>	 Click/ Double-click the left button	Select Icon/ Field
<Esc>	 Click the right button	Jump to the Exit menu or return to the previous from a submenu
<+>	X	Increase the numeric value or make changes
<->		Decrease the numeric value or make changes
<F1>		General Help
<F4>		CPU Specifications
<F5>		Enter Memory-Z
<F6>		Load optimized defaults
<F10>		Save Change and Reset
<F12>		Save a screenshot to a FAT/FAT32 USB drive

Sub-Menu

If you find a point symbol to the left of certain fields, that means a sub-menu can be launched for additional options. You can use the arrow keys or mouse to highlight the field and press <Enter> or double-click the left mouse button to enter the sub-menu. If you want to return to the previous menu, just press <Esc> or click the right mouse button.

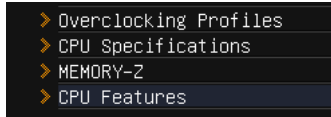

General Help

The General Help screen lists the appropriate keys to use for navigation. You can call up this screen from any menu by simply pressing <F1>. Press <Esc> to exit the Help screen.

SETTINGS

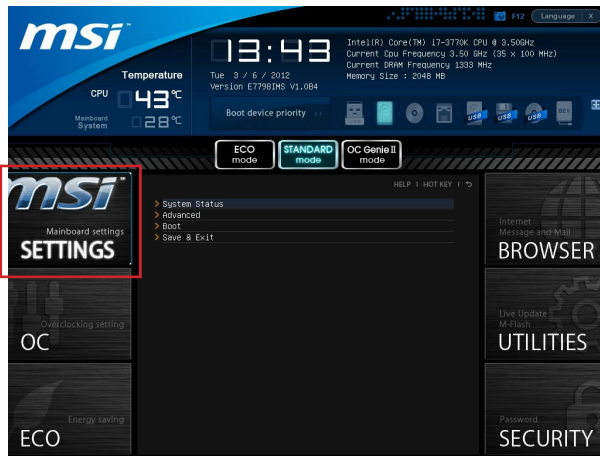

System Status

► System Date

This allows you to set the system date that you want (usually the current date). The format is <day> <month> <date> <year>.

day	Day of the week, from Sun to Sat, determined by BIOS. Read-only.
month	The month from Jan. through Dec.
date	The date from 1 to 31 can be keyed by numeric function keys.
year	The year can be adjusted by users.

► System Time

This allows you to set the system time that you want (usually the current time). The time format is <hour> <minute> <second>.

► SATA Port1~6

Shows devices connected to specific SATA ports.

Important

If your device is not displayed, turn off computer and re-check SATA cable and power cable connections to the device.

► System Information

Shows detailed system information, including CPU type, BIOS version, and Memory (read only).

Advanced

▶ PCI Subsystem Settings

Press <Enter> to enter the sub-menu.

▶ PCIE GEN3

This item is used to enable/ disable the PCIe generation 3 support.

▶ PCI Latency Timer

Controls how long each PCI device can hold the bus before another takes over.

When set to higher values, every PCI device can conduct transactions for a longer time and thus improve the effective PCI bandwidth.

▶ ACPI Settings

Press <Enter> to enter the sub-menu.

▶ ACPI Standby State

Specifies the power saving mode for ACPI function

[S1] Sleep Mode. Hardware remains on.

[S3] Suspend to RAM. Turns off hardware. (Recommended)

▶ Power LED

Configures how the system uses power LEDs on the case to indicate sleep/ suspend state.

[Single] The power LED turns off during the sleep/suspend mode.

[Dual] The power LED changes its color to indicate the sleep/suspend state.

[Blinking] The power LED blinks to indicate the sleep/suspend state.

▶ Integrated Peripherals

Press <Enter> to enter the sub-menu.

▶ Onboard LAN Controller

This item allows you to enable/ disable the onboard LAN controller.

▶ LAN Option ROM

This item is used to decide whether to invoke the Boot ROM of the onboard LAN.

▶ SATA Mode

This item is used to specify RAID/ IDE/ AHCI mode for SATA port.

Important

You cannot switch between AHCI and IDE if you already have your operating system installed. If you have installed your OS using AHCI and you clear your BIOS/reset to default settings, you will need to change this function back to AHCI to ensure proper functionality.

▶ SATA1~6 Hot Plug

These items are used to enable/ disable the SATA ports hot plug support.

▶ HD Audio Controller

This item allows you to enable/ disable the HD audio controller.

▶ HPET

The HPET (High Precision Event Timers) is a component that is part of the chipset. You can enable it, and will provide you with the means to get to it via the various ACPI methods.

▶ Integrated Graphics Configuration

Press <Enter> to enter the sub-menu.

▶ Initiate Graphic Adapter

Choose which adapter you wish to make the primary option

[IGD] Integrated Graphics Display

[PEG] PCI-Express Graphics Device

▶ Integrated Graphics Share Memory

The system shares memory to the onboard graphics. This setting controls the exact memory size shared to the onboard graphics.

▶ DVMT Memory

Specify the size of DVMT memory to allocate for video memory.

▶ IGD Multi-Monitor

Enables both integrated and discrete graphics at the same time. When disabled, it will default to Initiated Graphics Adapter selection.

▶ Intel(R) Rapid Start Technology

Press <Enter> to enter the sub-menu.

▶ Intel(R) Rapid Start Technology

This item is used to enable/ disable the Intel Rapid Start technology.

▶ USB Configuration

Press <Enter> to enter the sub-menu.

▶ USB Controller

This item allows you to enable/ disable the integrated USB 2.0 controller.

▶ Legacy USB Support

Enable or disable support for USB keyboards, mice and floppy drives. You will be able to use these devices with operating systems that do not support USB.

▶ Super IO Configuration

Press <Enter> to enter the sub-menu.

▶ Serial(COM) Port 0 Configuration

Press <Enter> to enter the sub-menu.

▶ Serial (COM) Port0

This item allows you to enable/ disable the serial port.

▶ Serial (COM) Port0 Settings

Select an address and corresponding interrupt for the serial port.

▶ Parallel(LPT) Port Configuration

Press <Enter> to enter the sub-menu.

▶ Parallel(LPT) Port

This item allows you to enable/ disable the parallel port.

▶ Parallel(LPT) Port Settings

Select an address and corresponding interrupt for the parallel port.

▶ Device Mode

Select a device mode for the parallel port.

▶ Hardware Monitor

Press <Enter> to enter the sub-menu.

▶ CPU Smart Fan Target

Controls CPU fan speed automatically depending on the current temperature and to keep it with a specific range. If the current CPU temperature reaches the target value, the smart fan function will be activated.

▶ SYS Fan1/ 2 Control

These items allow users to select how percentage of speed for the SYSFAN1/ 2.

▶ CPU/ System Temperature, CPU FAN/ SYS FAN 1/ 2 Speed

These items show the current status of all of the monitored hardware devices/ components such as CPU temperature/ system temperature and the few fans' speeds.

▶ Intel(R) Smart Connect Configuration

Press <Enter> to enter the sub-menu.

▶ Intel(R) Smart Connect Technology

This item allows you to enable/ disable Intel® Smart Connect Technology. When you enable it, the system will be woked periodically from Sleep/Standby mode for a brief period of time to update programs.

▶ Power Management Setup

Press <Enter> to enter the sub-menu.

▶ EuP 2013

Energy Using Products Lot 6 2013 (EUP) reduces power consumption when system is off or in standby mode.

Note: When enabled, the system will not support RTC wake up event functions.

▶ Restore after AC Power Loss

This item specifies whether your system will reboot after a power failure or interrupt occurs. Settings are:

[Power Off] Always leaves the computer in the power off state.

[Power On] Always leaves the computer in the power on state.

[Last State] Restore the system to the status before power failure or interrupt occurred.

▶ Wake Up Event Setup

Press <Enter> to enter the sub-menu.

▶ Wake Up Event By

Setting to [BIOS] activates the following fields, and use the following fields to set the wake up events. Setting to [OS], the wake up events will be defined by OS.

▶ Resume By RTC Alarm

The field is used to enable or disable the feature of booting up the system on a scheduled time/date.

▶ Date/ HH:MM:SS

If Resume By RTC Alarm is set to [Enabled], the system will automatically resume (boot up) on a specific date/hour/minute/second specified in these fields (using the <+> and <-> to select the date & time settings).

▶ Resume By PCI or PCI-E Device

When set to [Enabled], the feature allows your system to be awakened from the power saving modes through any event on PCI/ PCIe device.

▶ Resume From S3 by USB Device

The item allows the activity of the USB device to wake up the system from S3 (Suspend to RAM) sleep state.

▶ Resume From S3/S4/S5 by PS/2 Mouse/ Keyboard

These items determine whether the system will be awakened from what power saving modes when input signal of the PS/2 mouse/ keyboard is detected.

Boot

▶ Full Screen Logo Display

[Enabled] The OS boots straight to the GUI without showing the POST screen,

[Disabled] Shows the POST messages at boot.

== Boot Option Priorities==

▶ 1st~9th Boot

These items are used to prioritize the installed boot devices.

▶ USB KEY Drive BBS Priorities/ UEFI Boot Drive BBS Priorities

▶ 1st~8th Boot

These items are used to prioritize the installed USB key drives/ UEFI boot drives.

Save & Exit

▶ Discard Changes and Exit

This it is used to abandon all changes and exit setup.

▶ Save Changes and Reboot

This item is used to save changes and reboot the system.

▶ Save Changes

This item is used to save changes.

▶ Discard Changes

This item is used to abandon all changes.

▶ Restore Defaults

This item is used to load the optimized default values set by the BIOS vendor.

== Boot Override ==

The installed storage devices will appear on this menu, you can select one of them be a boot device.

▶ Built-in EFI Shell

Use this item to enter the EFI Shell.

OC

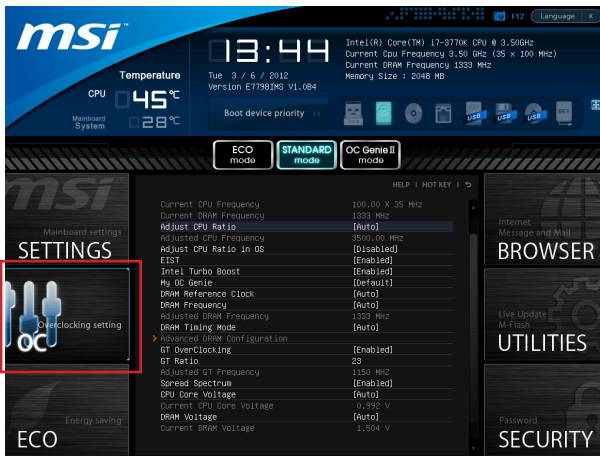
**Important**

- *Overclocking your PC manually is only recommended for advanced users.*
- *Overclocking is not guaranteed, and if done improperly, can void your warranty or severely damage your hardware.*
- *If you are unfamiliar with overclocking, we advise you to use OC Genie for easy overclocking.*

▶ **Current CPU/ DRAM Frequency**

These items show the current clocks of CPU and Memory speed. Read-only.

▶ **Adjust CPU Ratio**

Controls the multiplier that is used to determine internal clock speed of the processor. This feature can only be changed if the processor supports this function.

▶ **Adjusted CPU Frequency**

It shows the adjusted CPU frequency. Read-only.

▶ **Adjust CPU Ratio in OS**

Enable this item to allow CPU ratio changes in the OS by using MSI Control Center II.

▶ **EIST**

Enhanced Intel SpeedStep technology allows you to set the performance level of the microprocessor whether the computer is running on battery or AC power. This field only appears with installed CPUs that support this technology.

▶ **Intel Turbo Boost**

Enables or disables Intel Turbo Boost which automatically boosts CPU performance above rated specifications (when applications requests the highest performance state of the processor).

▶ My OC Genie

Press <Enter> to enter the sub-menu.

▶ Customize CPU Ratio

This item allows you to specific the CPU ratio for OC Genie function.

▶ My GT Overclock

This item allows you to enable/ disable the overclocking of integrated graphics for OC Genie function.

▶ GT Ratio

This item allows you to specific the GT ratio for OC Genie function.

▶ Adjusted my GT Ratio

It shows the iGPU frequency when OC Genie is started. Read-only.

▶ Customize DRAM Frequency

This item allows you to specific the DRAM frequency for OC Genie function.

▶ Adjusted My DRAM Frequency

It shows the adjusted DRAM frequency when OC Genie is started. Read-only.

▶ Extreme Memory Profile (X.M.P)

This item is used to enable/disable the Intel Extreme Memory Profile (XMP) when OC Genie is started.

▶ My OC Genie Intel C-State

This item is used to enable/disable the Intel C-State when OC Genie is started.

▶ My OC Genie Package C State limit

This field allows you to specific the C-state mode for OC Genie function.

▶ My OC Genie Long duration power limit

This field allows you to customize Long duration power limit for OC Genie function.

▶ My OC Genie Long duration maintained

This field allows you to customize Long duration maintained for OC Genie function.

▶ My OC Genie Short duration power limit

This field allows you to customize Short duration power imit for OC Genie function.

▶ My CPU Core Voltage/ My OC Genie CPU I/O Voltage/ My OC Genie DRAM Voltage/ My OC Genie GPU Voltage

These items are used to specific the voltage of CPU, Memory, GPU and chipset for OC Genie function.

▶ Current CPU Core Voltage/ Current CPU I/O Core Voltage/ Current DRAM Voltage/ Current GPU Voltage

These items show current CPU/ CPU I/O/ DRAM/ GPU voltage. Read-only.

▶ DRAM Reference Clock

This item allows you to specific the DRAM Reference Clock for CPU. Please note the overclocking behavior is not guaranteed.

▶ DRAM Frequency

This item allows you to adjust the DRAM frequency. Please note the overclocking behavior is not guaranteed.

▶ Adjusted DRAM Frequency

It shows the adjusted DRAM frequency. Read-only.

▶ DRAM Timing Mode

Select whether DRAM timing is controlled by the SPD (Serial Presence Detect) EEPROM on the DRAM module. Setting to [Auto] enables DRAM timings and the following “Advanced DRAM Configuration” sub-menu to be determined by BIOS based on the configurations on the SPD. Selecting [Link] or [Unlink] allows users to configure the DRAM timings for each channel and the following related “Advanced DRAM Configuration” sub-menu manually.

▶ Advanced DRAM Configuration

Press <Enter> to enter the sub-menu.

▶ Command Rate

This setting controls the DRAM command rate.

▶ tCL

Controls CAS latency which determines the timing delay (in clock cycles) of starting a read command after receiving data.

▶ tRCD

Determines the timing of the transition from RAS (row address strobe) to CAS (column address strobe). The less clock cycles, the faster the DRAM performance.

▶ tRP

Controls number of cycles for RAS (row address strobe) to be allowed to pre-charge. If insufficient time is allowed for RAS to accumulate before DRAM refresh, the DRAM may fail to retain data. This item applies only when synchronous DRAM is installed in the system.

▶ tRAS

Determines the time RAS (row address strobe) takes to read from and write to memory cell.

▶ tRFC

This setting determines the time RFC takes to read from and write to a memory cell.

▶ tWR

Determines minimum time interval between end of write data burst and the start of a pre-charge command. Allows sense amplifiers to restore data to cell.

▶ tWTR

Determines minimum time interval between the end of write data burst and the start of a column-read command; allows I/O gating to overdrive sense amplifiers before read command starts.

▶ tRRD

Specifies the active-to-active delay of different banks.

▶ tRTP

Time interval between a read and a precharge command.

▶ tFAW

This item is used to set the tFAW (four activate window delay) timing.

▶ tWCL

This item is used to set the tWCL (Write CAS Latency) timing.

▶ Advanced Channel 1/ 2 Timing Configuration

Press <Enter> to enter the sub-menu. And you can set the advanced memory timing for each channel.

▶ GT OverClocking

This item allows you to enable/ disable the overclocking of integrated graphics.

▶ GT Ratio

This setting controls the ratio of integrated graphics frequency to enable the integrated graphics to run at different frequency combinations.

▶ Adjusted GT Frequency

It shows the iGPU frequency. Read-only.

▶ Spread Spectrum

This function reduces the EMI (Electromagnetic Interference) generated by modulating clock generator pulses.

Important

- *If you do not have any EMI problem, leave the setting at [Disabled] for optimal system stability and performance. But if you are plagued by EMI, select the value of Spread Spectrum for EMI reduction.*
- *The greater the Spread Spectrum value is, the greater the EMI is reduced, and the system will become less stable. For the most suitable Spread Spectrum value, please consult your local EMI regulation.*
- *Remember to disable Spread Spectrum if you are overclocking because even a slight jitter can introduce a temporary boost in clock speed which may just cause your overclocked processor to lock up.*

▶ CPU Core Voltage/ DRAM Voltage.

These items are used to adjust the voltage of CPU and Memory.

▶ Current CPU Core Voltage/ Current DRAM Voltage

These items show current CPU/ DRAM voltage. Read-only.

▶ Overclocking Profiles

Press <Enter> to enter the sub-menu.

▶ Overclocking Profile 1/ 2/ 3/ 4/ 5/ 6

Press <Enter> to enter the sub-menu.

▶ Set Name for Overclocking Profile 1/ 2/ 3/ 4/ 5/ 6

Give a name by typing in this item.

▶ Save Overclocking Profile 1/ 2/ 3/ 4/ 5/ 6

Save the current overclocking settings to ROM for selected profile.

▶ Load/ Clear Overclocking Profile 1/ 2/ 3/ 4/ 5/ 6

Load/ Clear the stored profile settings from ROM.

▶ OC Profile Save to USB

Save the current overclocking settings to USB flash disk.

▶ OC Profile Load from USB

Load the stored settings from USB flash disk.

▶ CPU Specifications

Press <Enter> to enter the sub-menu. This sub-menu highlights all the key features of your CPU. The information will vary by model and is read-only. You can also access this information at any time by pressing [F4]. Press <Enter> to enter the sub-menu.

▶ CPU Technology Support

Press <Enter> to enter the sub-menu. The sub-menu shows the installed CPU technologies. Read only.

▶ MEMORY-Z

Press <Enter> to enter the sub-menu. This sub-menu highlights all the settings and timings of your DIMMs. This information will vary by model and is read-only. You can also access this information at any time by pressing [F5]. Press <Enter> to enter the sub-menu.

▶ DIMM1~4 Memory SPD

Press <Enter> to enter the sub-menu. The sub-menu displays the informations of installed memory.

▶ CPU Features

Press <Enter> to enter the sub-menu.

▶ Hyper-Threading

The processor uses Hyper-Threading technology to increase transaction rates and reduces end-user response times. The technology treats the two cores inside the processor as two logical processors that can execute instructions simultaneously. In this way, the system performance is highly improved. If you disable the function, the processor will use only one core to execute the instructions. Please disable this item if your operating system doesn't support HT Function, or unreliability and instability may occur.

▶ Active Processor Cores

This item allows you to select the number of active processor cores.

▶ Limit CPUID Maximum

It is designed to limit the listed speed of the processor to older operating systems.

▶ Execute Disable Bit

Can prevent certain classes of malicious "buffer overflow" attacks where worms can try to execute code to damage your system. It is recommended you keep this enabled always.

▶ Intel Virtualization Tech

Enhances virtualization and allows the system to act as multiple virtual systems. See Intel's official website for more information.

▶ Intel VT-D Tech

This item is used to enable/disable the Intel VT-D technology. For further information please refer to Intel's official website.

▶ Power Technology

This item allows you to select the Intel Dynamic Power technology mode.

▶ C1E Support

Enable system to reduce CPU power consumption while idle. Not all processors support Enhanced Halt state (C1E).

▶ OverSpeed Protection

Monitors current CPU draw as well as power consumption; if it exceeds a certain level, the processor automatically reduces its clock speed. For overclocking, it is recommended this feature is disabled.

▶ Intel C-State

C-state is a power management state that detects when the system is idle and lowers power consumption accordingly.

▶ Package C State limit

This field allows you to select a C-state mode.

▶ Long duration power limit (W)

This field allows you to adjust the TDP power limit for the long duration.

▶ Long duration maintained (s)

This field allows you to adjust the maintaining time for long duration power limit.

▶ Short duration power limit (W)

This field allows you to adjust the TDP power limit for the short duration.

▶ Primary/ Secondary Plane Current value (A)

These fields allow you to adjust over current value of CPU (primary plane)/ iGPU (secondary plane) for turbo ratio.

▶ Primary/ Secondary plane turbo power limit (W)

These fields allow you to adjust the turbo power limit of CPU (primary plane)/ iGPU (secondary plane) for turbo boost.

ECO

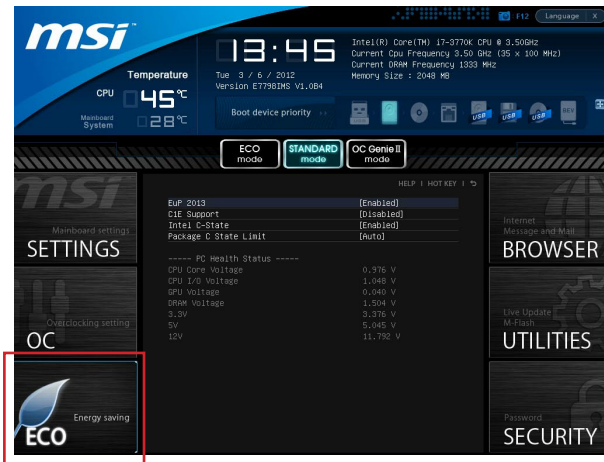
**Important**

Once you click the “ECO” button in the pre-set area, some items in ECO menu will be fixed and un-adjustable.

▶ **EuP 2013**

Energy Using Products Lot 6 2013 (EUP) reduces power consumption when system is off or in standby mode.

Note: When enabled, the system will not support RTC wake up event functions.

▶ **C1E Support**

To enable this item to reduce the CPU power consumption while idle. Not all processors support Enhanced Halt state (C1E).

▶ **Intel C-State**

C-state is a power management state that detects when the system is idle and lowers power consumption accordingly.

▶ **Package C State limit**

This field allows you to select a C-state mode.

▶ **CPU Core Voltage/ CPU I/O Voltage/ GPU Voltage/ DRAM Voltage/ 3.3V/ 5V/ 12V**

These items show the voltages. Read only.

BROWSER

Please install the MSI "Winki" application first in the Windows operating system with the MSI Driver Disc before using the browser. Then you can click the BROWSER to access the Internet, e-mail and instant messaging.



Installing Winki

To install Winki, follow the steps below:





1. Power on your computer and enter Windows operating system.
2. Insert MSI Driver Disc into the optical drive. The setup screen will automatically appear.
3. Click Driver tab.
4. Click OTHERS button.
5. Select Winki to start installing.
6. When finished, restart your computer.

Updating the BIOS with Live Update

This section tells you how to update the BIOS by using the Live Update utility before entering Operating System. Live Update will update the BIOS automatically when connecting to the Internet. To update the BIOS with the Live Update utility:

1. Click Live Update button  on the BIOS UTILITIES menu. (The Winki must be installed).



2. Setup the connection by click the setting button  if necessary.
3. Click the next button .
4. Live Update will automatically detect the version of BIOS and download the appropriate file.

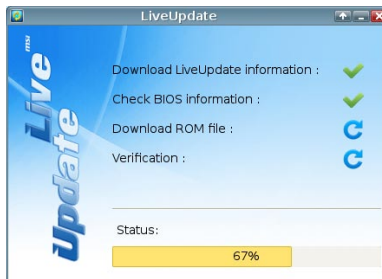

5. Click the confirm button  to update the BIOS.



Important

Do not unplug or shut off your system during BIOS Flash. Incorrect BIOS flashing can cause the motherboard to not POST. Please ensure you have the correct version and model of your motherboard BIOS when updating.

UTILITIES

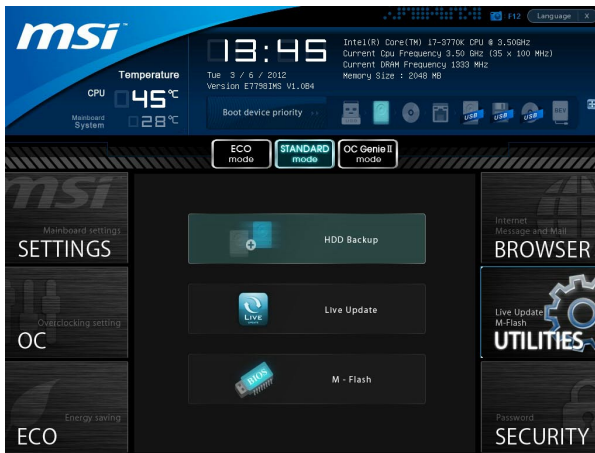

► HDD Backup

Hard disk storage backups and restoring is one of the most common and important tasks. Use this utility to create an image of your HDD partitions and re-load them when necessary.

Important

The HDD Backup can't back up (/restore) image to (/from) a partition where itself was installed, so it's strongly recommended to divide HDD into 2 partitions at least (1st for OS; 2nd for data).

For HDD with single partition only, the requirements for HDD Backup are:

1. An additional partition from another HDD (ex. USB HDD) for HDD Backup to back up (/restore) image to (/from) it.
2. Executing Winki stored in USB flash drive/ MSI Driver Disc by pressing <F11> to choose boot device during POST.

► Live Update

This tool can detect and update your BIOS online so that you won't need to spend time searching manually.

Important

HDD Backup and Live Update request Winki, please install the "Winki" software application from MSI Driver Disc in Windows first. And then you can access these two utilities by clicking their respective buttons.

► M-Flash**► BIOS Boot Function**

This allows you to enable/ disable the system to boot from the BIOS file inside USB drive (FAT/ 32 format only).

► Select one file to Boot

When the BIOS Boot function as sets to [Enabled], this item is selectable. This item allows to select particular BIOS file from the USB/ Storage (FAT/ 32 format only) drive. And the system will boot from selected BIOS file.

► Save BIOS to storage

Please setup a specific folder in specific USB/ Storage drive to save BIOS file from BIOS ROM chip data. Note: it only supports FAT/ 32 file system drive.

► Select one file to update BIOS

This item allows you to select a particular BIOS file from the USB/ Storage (FAT/ 32 format only) drive for updating BIOS.

SECURITY

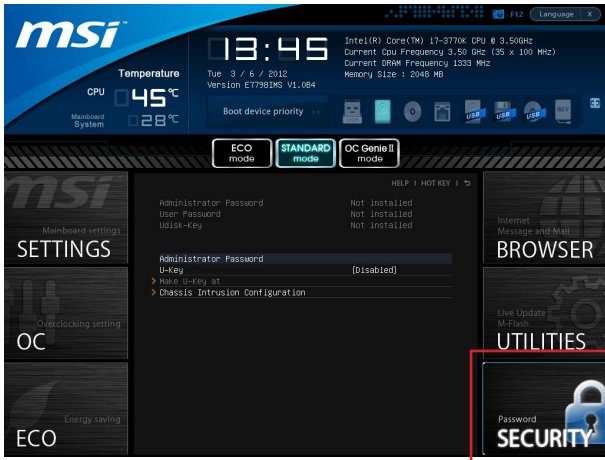

► **Administrator Password**

Set the administrative password that will be required to enter the BIOS.

► **User Password**

Set the user password that will be required to enter the operating system.

Important

When selecting the Administrative / User Password items, a password box will appear on the screen. Type the password then press <Enter>. The password typed now will replace any previous set password from CMOS memory. You will be prompted to confirm the password. You may also press <Esc> to abort the selection.

To clear a set password, press <Enter> when you are prompted to enter a new password. A message will confirm the password is being disabled. Once the password is disabled, you can enter the setup and OS without authorization.

► **U-Key**

Enable or disable USB driver device as key. This requires the USB device to be plugged in for access to the computer..

► **Make U-Key at**

When the "U-Key" as sets to [Enabled], this item is selectable. This item allows you to specify the USB drive.

► **Chassis Intrusion Configuration**

Press <Enter> to enter the sub-menu.

► **Chassis Intrusion**

Enables or disables the feature of recording the chassis intrusion status and issuing a warning message if opened. To clear the warning logs, set the field to [Reset]. The setting of the field will return to [Enabled] later.

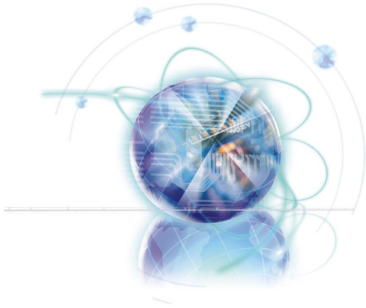

Appendix A

Realtek Audio

The Realtek audio provides 8-channel DAC. To achieve the 8-channel sound effect, the 7th and 8th channels must be plugged into the output on the front panel. The section will tell you how to install driver and use the software.

Installing the Realtek HD Audio Driver

You need to install the HD audio driver for Realtek audio codec to function properly before you can get access to 2-, 4-, 6-, 8- channel audio operations. Follow the procedures described below to install the drivers for different operating systems.

Installation for Windows®

For Windows® XP, you must install Windows® XP Service Pack3 or later before installing the driver.

The following illustrations are based on Windows® 7 environment and could look slightly different if you install the drivers in different operating systems.

1. Insert the application DVD into the DVD-ROM drive. The setup screen will automatically appear.
2. Click Driver tab.
3. Click AUDIO button.
4. Select Realtek HD Audio Drivers to start installing the drivers.



5. Click Next to install the Realtek High Definition Audio Driver.
6. Follow the on-screen instructions to install drivers.
7. Click Finish to restart the system.

Important

The HD Audio Configuration software utility is under continuous update to enhance audio applications. Hence, the program screens shown here in this section may be slightly different from the latest software utility and shall be held for reference only.

Software Configuration

After installing the audio driver, the “Realtek HD Audio Manager” icon will appear at the notification area (lower right of the screen). You may double click the icon and the GUI will pop up accordingly.

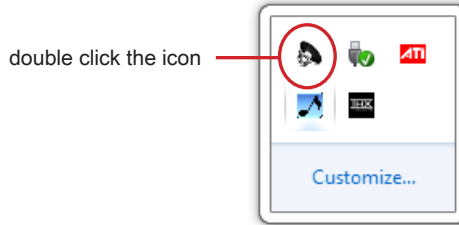

It is also available to enable the audio driver by clicking the Realtek HD Audio Manager from the Control Panel.

Software panel overview

The following figure describes the function of the Realtek HD Audio Manager panel.

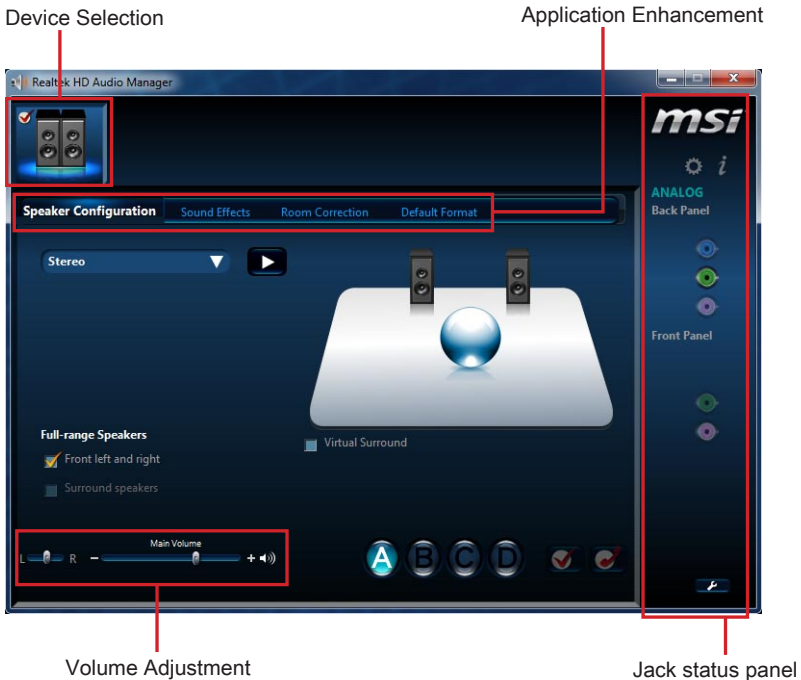

■ **Device Selection**

Here you can select a audio output source to change the related options. The “check” sign (in orange) indicates the devices as default.

■ **Volume Adjustment**

You can control the volume or balance the right/left side of the speakers that you plugged in front or rear panel by adjust the bar.

■ **Application Enhancement**

The array of options will provide you a complete guidance of anticipated sound effect for both output and input device.

■ **Jack status panel**

This panel depicts all render and capture devices currently connected with your computer.

Auto popup dialog

When you plug into the device at the jack, a dialogue window will pop up asking you which device is current connected.

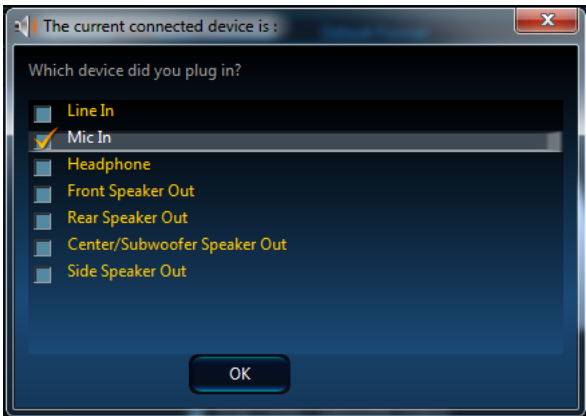

As you know, each jack corresponds to its default setting, you can refer to the next section “Hardware Default Setting”.

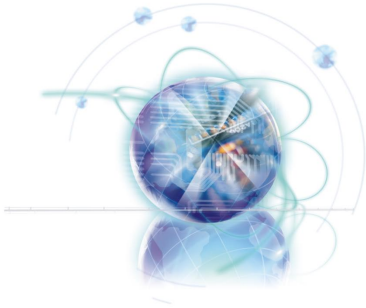

Appendix B

Intel SBA

Intel® Small Business Advantage (Intel® SBA) provides an out-of-the-box hardware-based security and productivity suite designed for the small business user. Intel SBA includes a customizable user interface and several bundled Intel applications.

Prerequisites

■ Supported Operating Systems

Intel SBA supports following OS:

- Windows 7 Professional 64-bit and 32-bit
- Windows 7 Enterprise 64-bit

■ Required User Permissions

You must run the installer and the customization wizard with a user that has local administrator permissions on the computer.

■ Windows Update Settings

In certain conditions, the **Windows Update** task in the PC Health Center application is disabled and cannot be enabled. This can occur if Intel SBA is installed on a computer where Windows Update was disabled during installation of the Windows operating system. The Windows Update task is shown in the GUI but is grayed out (disabled). Even if the end user enables Windows Update in the operating system, the PC Health Center task cannot be enabled. This means that the end user cannot use PC Health Center to manage Windows Update.

To prevent this, make sure that you do NOT select the **Never check for updates** option when installing the Windows operating system.

■ Windows Task Scheduler

Some PC Health Center tasks are applications that can also be used directly from the operating system and scheduled via the Windows Task Scheduler. When a task is set via PC Health Center, an alarm clock is set that will wake up the computer if it is turned off. Defining a scheduled time for an application/task outside of PC Health Center does not set an alarm clock. This means that the computer will not be woken up to do the task.

For this reason, it is NOT recommended to define schedules for these applications:

- Windows Updates
- Windows Backup and Restore
- Disk defragmentation

Instead, let the end user set the schedule for all these tasks via PC Health Center.

Installing Intel SBA

This procedure describes how to install Intel SBA.

■ To install Intel SBA:

1. Logon to the computer with a user that has administrator privileges.
2. Insert the application DVD into the DVD-ROM drive. The setup screen will automatically appear.
3. Click OTHERS tab.
4. Select Intel SBA to start installing.
5. Follow the on-screen instructions to install.

Software Configuration

After installation of the Intel SBA software is complete, the Intel SBA service is started. The desktop, system tray, and programs menu include shortcuts to the GUI of Intel SBA.

Software panel overview

The following figure describes the function of the Intel SBA control panel.

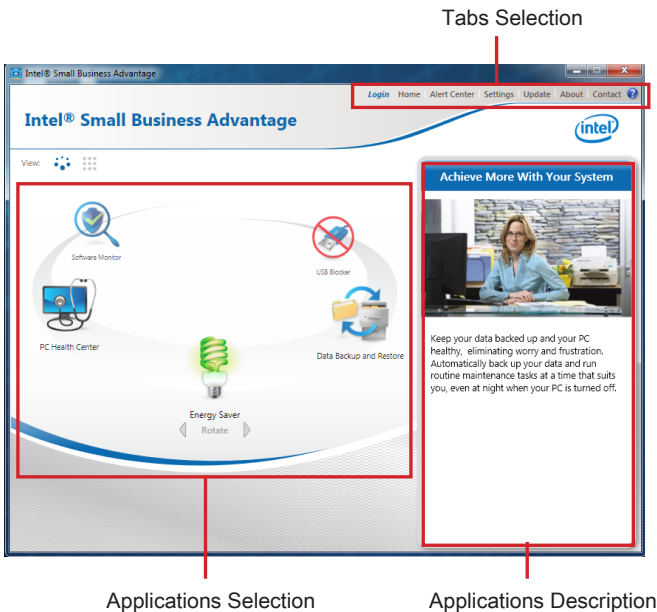

Password settings

By default, the system is in an unconfigured state. Before the hardware capabilities can be used by Intel SBA software, the system must be configured. This is done in the Settings > Password Settings tab in the main menu of the GUI.

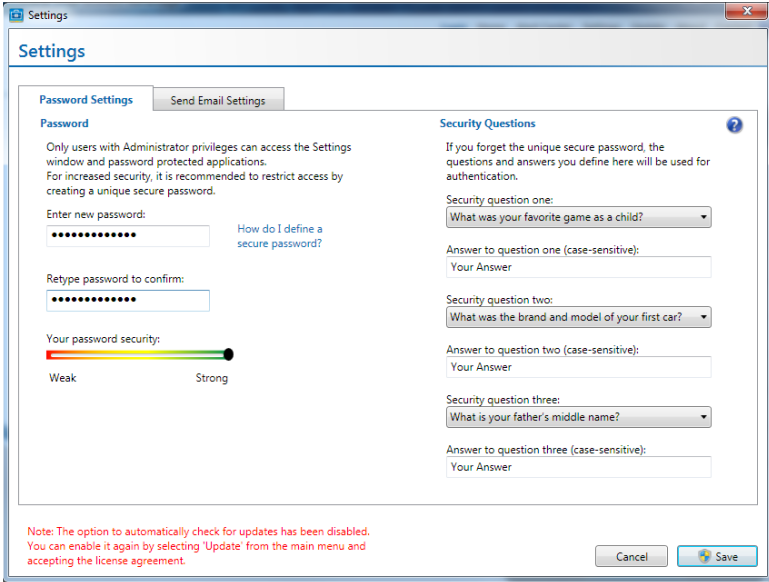

Fill out the form to create the new password and click "Save". You will be asked to enter the password when you want to start using Intel SBA.

Important

- Upon completion of the password settings, please keep your password secure.
- Please remember your answers to the security questions.

Help Button

There is a help button  on the top right. If you need to know detailed introductions. Just click on the help button, to get the information.